

6427525 N E C ELECTRONICS INC 05E 22785 D  
**BIPOLAR ANALOG INTEGRATED CIRCUIT**

**$\mu$ PC1245V**  
 T-77-05-07

## FM IF SYSTEM WITH DIFFERENTIAL PEAK DETECTOR

### DESCRIPTION

The  $\mu$ PC1245V is a monolithic integrated circuit that provides all the functions of an FM-IF system. It includes a three-stage IF amplifier/limiter configuration with level detectors for each stage, a differential peak detector, and an audio amplifier that features a muting (squelch) circuit. It also includes desirable features such as AGC for the RF tuner, an AFC drive circuit, an output signal to drive a tuning meter and/or provides stereo switching logic, and a station detector that provides a stop signal for search control in Electronically Tuned Radio. The  $\mu$ PC1245V is suitable for use in automotive radio receivers. Outline is 19 leads Vertical Dual In-Line Package. (V-DIP).

### FEATURES

- High S+N/N ratio: 67 dB TYP.
- Low distortion with single tune coil: 0.1 % TYP.
- Soft muting circuit
- Programmable muting threshold and attenuation level
- Programmable AGC voltage and threshold for RF amplifier
- Programmable deviation where muting occurs and stop signal width
- Reduction of the occupation of mounting area in P.C. Board and hand-insertion time, due to the external shape of the V-DIP.

### PACKAGE DIMENSIONS (Unit : mm)

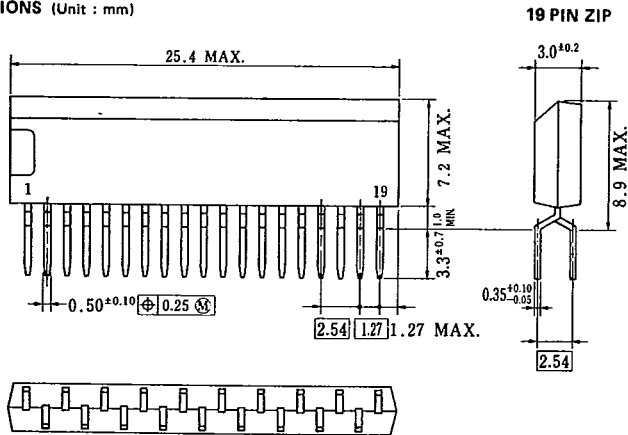

P19V-254B

**μPC1245V**

6427525 N E C ELECTRONICS INC

05E 22786 D —

*T-77-05-07***ABSOLUTE MAXIMUM RATINGS (T<sub>a</sub> = 25 °C)**

Supply Voltage	V <sub>CC</sub>	16	V
Input Voltage	V <sub>I</sub>	3.0	V
Package Dissipation (T <sub>a</sub> = 25 °C)	P <sub>D</sub>	430	mW
Operating Temperature	T <sub>opt</sub>	-30 to +75	°C
Storage Temperature	T <sub>stg</sub>	-40 to +125	°C

**RECOMMENDED OPERATING CONDITION**

Supply Voltage Range	V <sub>CC</sub>	7.0 to 15	V
----------------------	-----------------	-----------	---

**ELECTRICAL CHARACTERISTICS (T<sub>a</sub> = 25 °C, V<sub>CC</sub> = 10 V, f = 10.7 MHz, f<sub>MOD</sub> = 400 Hz, Δf = ±22.5 kHz)**

CHARACTERISTIC	SYMBOL	MIN.	TYP.	MAX.	UNIT	TEST CONDITION
Supply Current	I <sub>CC</sub>	12	18	25	mA	No Signal
Recovered AF Voltage	U <sub>OAF</sub>	85	130	175	mV <sub>r.m.s.</sub>	U <sub>i</sub> = 80 dBμV
Limiting Sensitivity	U <sub>i</sub> (limit) 1	38	44	50	dBμV	U <sub>o</sub> = U <sub>oAF</sub> - 3 dB
	U <sub>i</sub> (limit) 2	42	50	58	dBμV	U <sub>o</sub> = U <sub>oAF</sub> - 3 dB, Mute ON, R <sub>3</sub> = 22 kΩ, R <sub>8</sub> = 5.6 kΩ
Total Harmonic Distortion	THD		0.1	0.5	%	U <sub>i</sub> = 80 dBμV
Signal to Noise Ratio	S/N	60	67		dB	U <sub>i</sub> = 80 dBμV
AM Rejection Ratio	AMR	30	42		dB	U <sub>i</sub> = 80 dBμV, AM: 400 Hz, 30 % mod
Signal Meter Output Voltage	V <sub>s1</sub>		0	0.3	V	U <sub>i</sub> = 0 dBμV, R <sub>2</sub> = 4.7 kΩ
	V <sub>s2</sub>	0.4	1.0	3.0	V	U <sub>i</sub> = 60 dBμV, R <sub>2</sub> = 4.7 kΩ
	V <sub>s3</sub>	4.5	5.3	6.3	V	U <sub>i</sub> = 100 dBμV, R <sub>2</sub> = 4.7 kΩ
AGC Output	V <sub>AGC1</sub>	9.0			V	U <sub>i</sub> = 0 dBμV, V <sub>16</sub> = 3.0 V
	V <sub>AGC2</sub>		0.1	0.5	V	U <sub>i</sub> = 100 dBμV, V <sub>16</sub> = 3.0 V
AFC Output	V <sub>AFC</sub>	4.6	5.2	5.8	V	U <sub>i</sub> = 80 dBμV
Stop Signal Width	BWSD		100		kHz	U <sub>i</sub> = 80 dBμV, R <sub>5</sub> = 5.6 kΩ, V <sub>SD</sub> = 5 V, R <sub>9</sub> = 3.3 kΩ

6427525 N E C ELECTRONICS INC

$\mu$ PC1245V  
05E 22787 D

BLOCK DIAGRAM

T-77-05-07

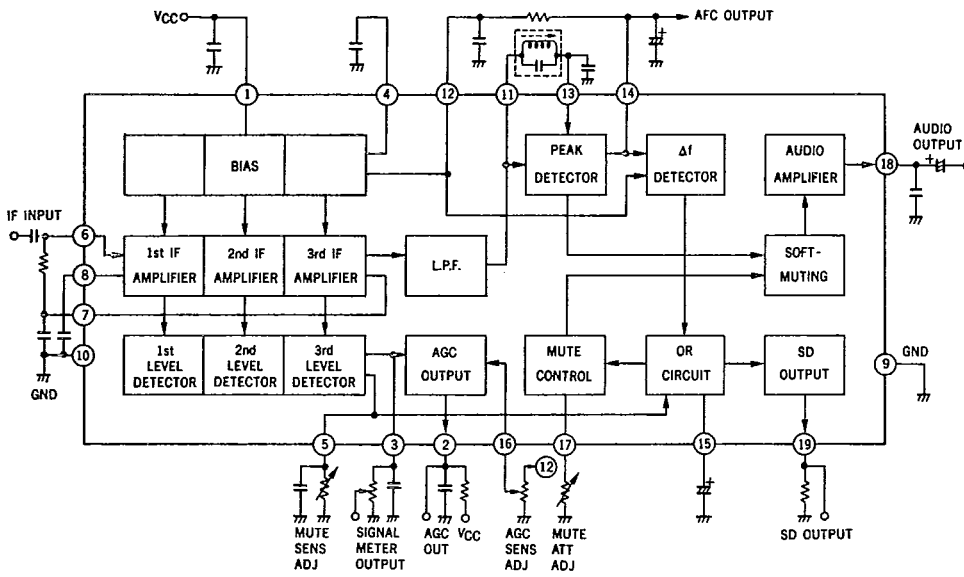

CONNECTION DIAGRAM

PIN No.	CONNECTION	PIN No.	CONNECTION
1	VCC	2	AGC Output
3	Signal Meter Output	4	Bypass
5	Mute Sensitivity Adj	6	IF Input
7	IF Bypass	8	IF Bypass
9	GND	10	GND
11	Detector Input (+)	12	Reference Voltage
13	Detector Input (-)	14	AFC Output
15	Bypass	16	AGC Sensitivity Adj
17	Mute Att Adj	18	Audio Output
19	SD Output		

5



6427525 N E C ELECTRONICS INC

$\mu$ PC1245V  
05E 22789 D

T-77-05-07

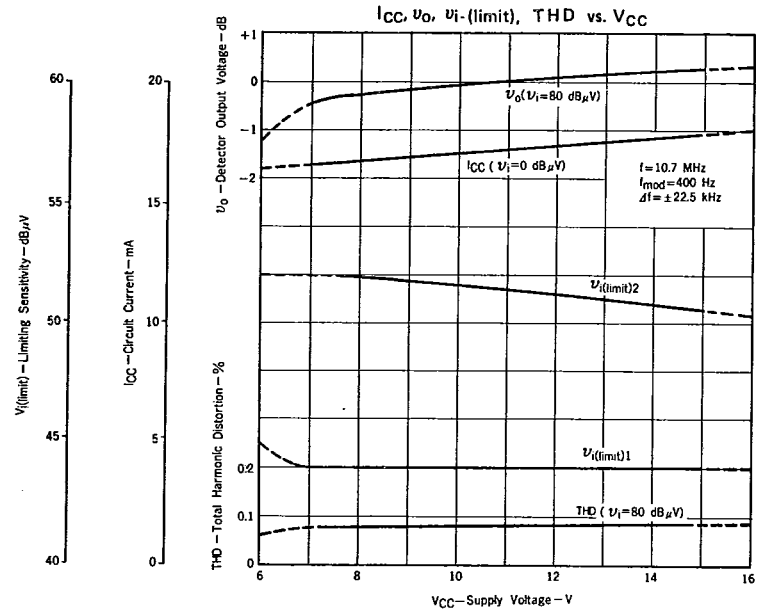
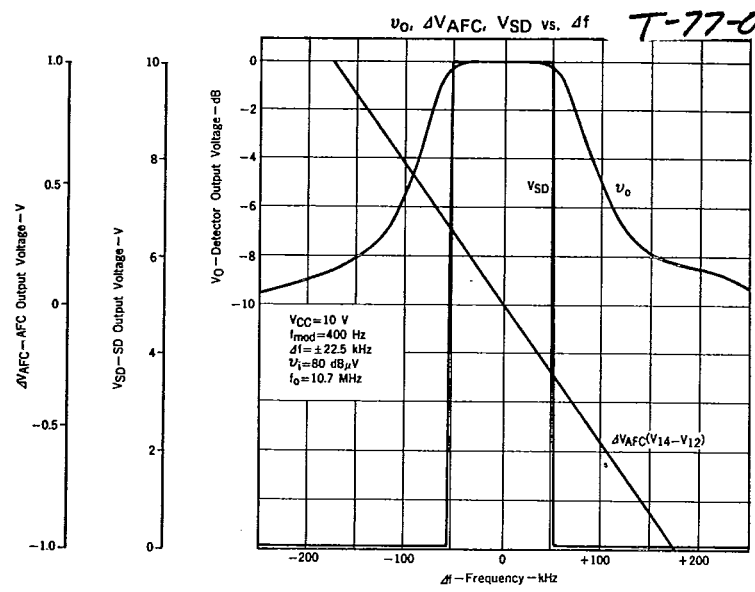

5

**μPC1245V**  
 6427525 N E C ELECTRONICS INC

05E 22790 D

T-77-05-07

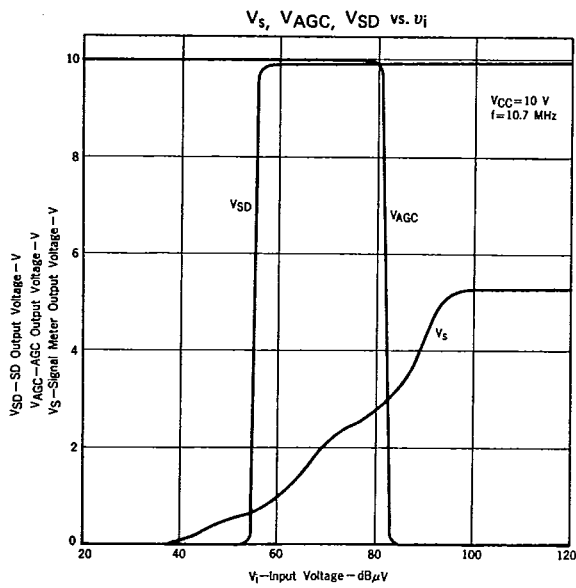
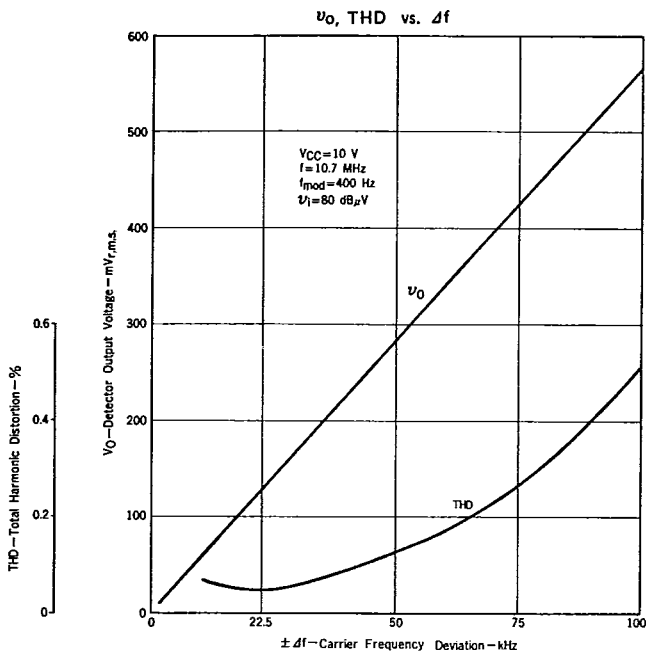

6427525 N E C ELECTRONICS INC

$\mu$ PC1245V  
05E 22791 D

TYPICAL APPLICATION

T-77-05-07

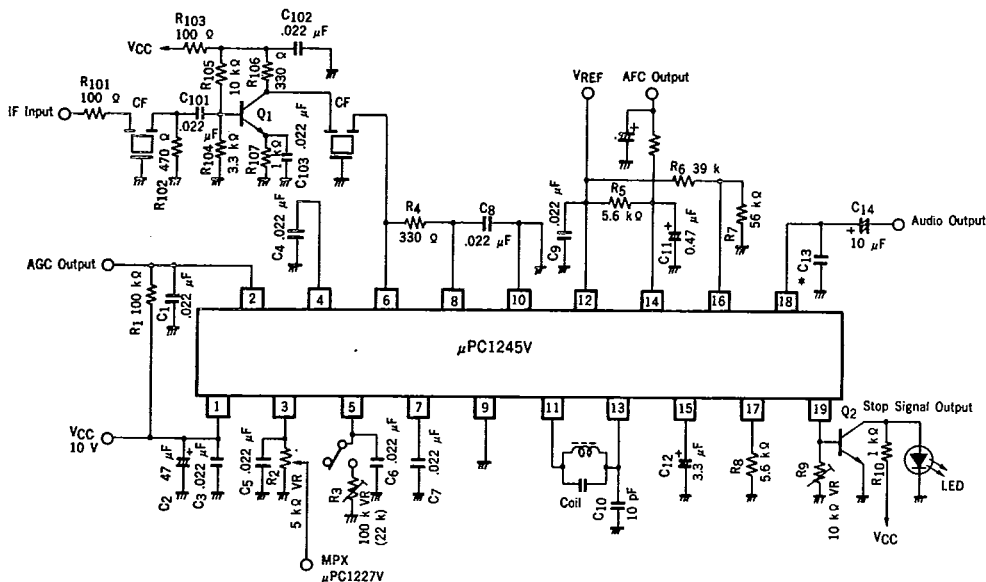

- Coil : 119ACS-14891Z (TOKO) or equivalent
- Ceramic filter : SFE10.7MS2 (MURATA) or equivalent
- Q1 : 2SC1675, 2SC1674 or equivalent
- Q2 : 2SC945 or equivalent
- \* C13 : 0.01 μF 75 μs deemphasis

$\mu$ PC1245V  
6427525 N E C ELECTRONICS INC

05E 22792 D

COMPONENT LAYOUT FOR P.C. ASSEMBLY (Copper Side)

T-77-05-07

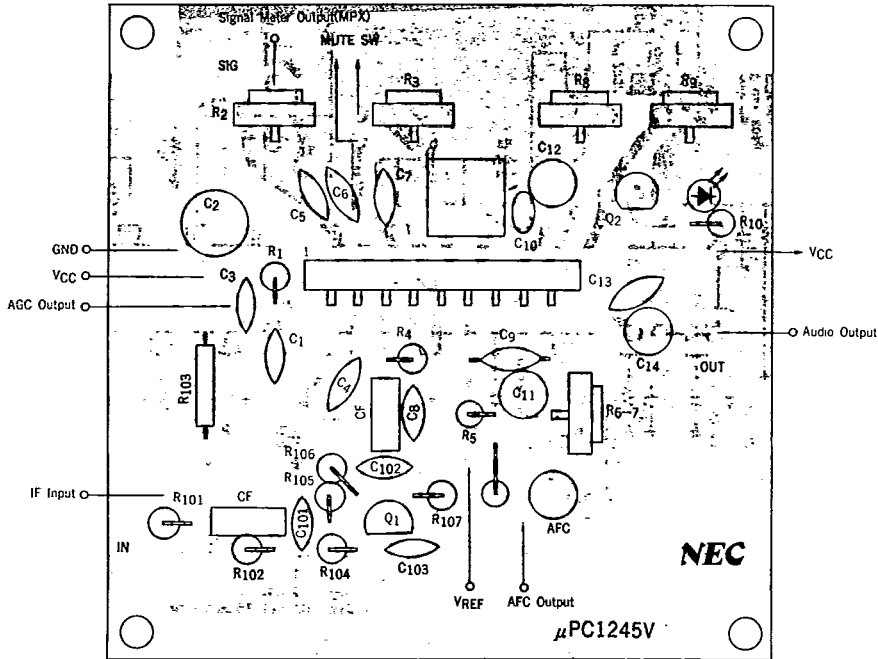



6427525 N E C ELECTRONICS INC

 $\mu$ PC1245V  
05E 22793 D

T-77-05-07

**GENERAL DESCRIPTION OF OPERATION**

The FM modulation signal of 10.7 MHz intermediate frequency band (IF) supplied from pin (6) is amplified by a three-stage IF amplifier circuit (voltage gain  $A_v=70$  dB) and the amplitude is limited by limiters. The output of IF amplifier circuit is removed 10.7 MHz harmonic component by low-pass filter, is outputted to pin (11), and is simultaneously inputted to the peak detection circuit. The signal outputted to pin (11) is also inputted to other input (pin (13)) of the peak detection circuit through the external L-C resonance circuit. The audio signal detected in the peak detection circuit is outputted to pin (18) through the soft muting and audio amplifier circuits.

While, the carrier signal from a three-stage IF amplifier circuit is inputted to level detection circuit and DC current corresponded to carrier signal level is outputted to pins (3) and (5). DC current outputted to pin (3) is used for the signal meter drive, MPX control, and AGC sensitivity setting, and DC current outputted to pin (5) is employed to the level muting control voltage.

AGC comparator compares pin (16) reference voltage and pin (3) voltage then output from pin (2) the signal that high level against low input level and low against strong.

$\Delta f$  detecting circuit delivers DC current proportioned to absolute value of the frequency slip from the tuning point. This output and pin (5) output voltage is combined in OR circuit, the combined output is supplied to the mute control circuit, in the same time, is outputted from pin (19) as SD signal. Mute control circuit output controls the gain of the soft muting circuit and suppresses the noise at the low input level and detuning. Thus, the low noise audio signal is delivered from pin (18).

**DESCRIPTION OF FUNCTIONING CHARACTERISTICS****(1) Muting Characteristics**

Fig. 1 Muting Operation Principle Block Diagram

The muting operation is performed by muting control and soft muting circuits.

As shown in Fig. 1, the level detection output current proportioned to carrier input level is flowed to pin (5).

The voltage produced by resistor  $R_3$  is input to the mute control circuit, and controls the soft muting circuit. Consequently, the muting sensitivity can be set at random by means of changing the value of resistor  $R_3$ .

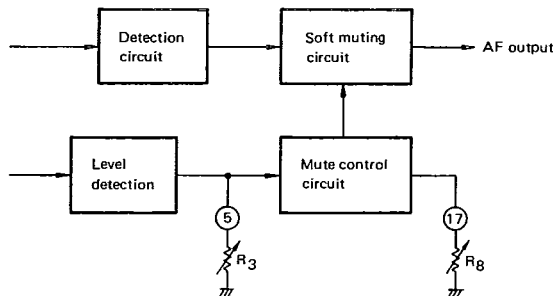
5

$\mu$ PC1245V  
6427525 N E C ELECTRONICS INC

05E 22794 D

T-77-05-07

The input and output characteristics in the case of changing the value of resistor  $R_3$  is shown in Fig. 3. In addition, the attenuation of the noise at a low input level or a tuning-out can be set freely by means of changing the value of resistor  $R_8$ .

Fig. 4 and 5 shows the attenuation characteristics of level muting and band muting in the case of changing the value of resistor  $R_8$ .

By above characteristics, the muting of the  $\mu$ PC1245V becomes free from the sound gap phenomena at the low input level or the tuning-out. since the attenuation varies corresponded to the carrier input level.

If level muting is unused, remove resistor  $R_3$  on pin ⑤ and connect pin ⑦ to GND, and if band muting is not required, short between pin ⑫-⑭ and open pin ⑮.

## (2) AGC and Signal Meter Output Characteristics

AGC and signal meter output circuits is operated by the level detection output of IF stage the same as the level muting. The signal meter output is one of amplified the output of the level detection circuit, the different point from usual circuit is the point of being outputed from the open corrector (current output) of PNP transistor. Therefore, the circuit has the degree of freedom in design, and is possible to arbitrary change the signal meter output voltage by means of the value of external resistor connected between pin ③-GND. In car radio set, the output voltage can be used for the blend control of stereo multiplex demodulator ( $\mu$ PC1227V for example) or the change of stereo-monoral.

Fig. 6 shows the signal meter output voltage characteristics for pin ③ load resistor  $R_2$  changed.

On the other hand, AGC used the front-end controls the gain of the front-end in order to prevent the following phenomena caused by when the carrier signal input in front-end is the strong input signal over 100 dB $\mu$ V.

- ① The output-wave distorts since the local oscillation power in the front-end is drawn.
- ② As input/output impedances in amplifier element is large changed, it may be caused that the frequency gap of tuning circuit, less selectivity, and interference.

The internal circuit supplies the signal meter output voltage to the internal comparator (AGC comparator), when higher than setting voltage in pin ⑩, the output level come to low is delivered from pin ②. Since AGC output circuit is open corrector output of NPN transistor, AGC voltage can be set freely, in addition, AGC operating level is possible to set freely by varing the setting voltage of pin ⑩. Also, AGC operating level is possible to simultaneously change by varing the value of resistor  $R_2$  for signal meter.

Fig. 7 and 8 shows the reference voltage and AGC characteristics in the case of changing the value of resistor  $R_2$  for signal meter respectively.

Besides, open the pin ⑩ in the case of AGC output is unused and connect the pin ③ to GND when signal meter output is unused. However, in the these cases AGC output can not used.

## (3) SD Output Characteristics

SD output circuit is the circuit for supply the signal to stop the auto-scan of the digital tuner system (D.T.S.), and is used on external two resistors and a transistor. In SD output circuit, OR output of  $\Delta f$  detecting circuit and level detection circuit is delivered to pin ⑲. Thus, Fig. 2 shows in the cahacteristics of the output current of pin ⑲ for the input signal or the frequency slip.

6427525 N E C ELECTRONICS INC

 $\mu$ PC1245V  
05E 22795 D

T-77-05-07

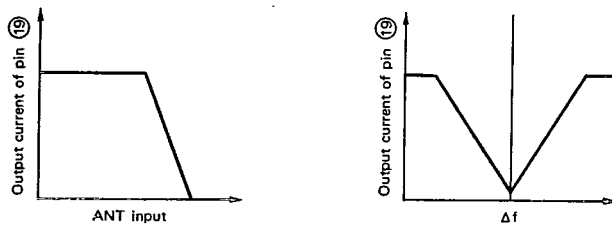

Fig. 2 Characteristics of Output Current of Pin 19

By above mentioned characteristics, SD sensitivity is possible to simultaneously change by means of the load resistor  $R_3$  for muting sensitivity setting. Also, SD band width can be set freely by changing the value of resistor  $R_3$  between pin 19-GND, because the output current of pin 19 changes like V characteristic curve shown in Fig. 2 against the frequency slip. In the same time, SD sensitivity is possible to change in some degree.

Fig. 9 shows the characteristic of SD sensitivity in case changed value of resistor  $R_3$ , and the characteristics for SD band-width and SD sensitivity setting in case changed value of resistor  $R_3$  are shown in Fig. 10 and 11 respectively.

Besides, connect the pin 19 to GND when SD output is unused.

#### (4) AFC Characteristic

AFC circuit corrects the frequency drift of the local oscillator in front-end, and is ever maintained the exact intermediate frequency. (10.7 MHz)

In principle, control is performed by feedback of the S curve characteristic of detection circuit, namely, the DC voltage proportioned to the frequency deviation supply to the varicap diode of the local oscillator in front-end.

AFC sensitivity (voltage variation for frequency deviation) in the  $\mu$ PC1245V can be set using external resistor  $R_5$  between pins 12-14.

Fig. 12 shows AFC sensitivity characteristic for changing the value of resistor  $R_5$  between pins 12-14.

By changing the value of resistor  $R_5$  between pins 12-14, the band-width of muting can be set freely.

Fig. 13 shows the characteristic of band-width in the case of changing the value of resistor  $R_5$ .

#### OVERALL CHARACTERISTICS

Using example of application circuit shown in Fig. 5, overall characteristic in the case of connections the multiplex demodulator (MPX)  $\mu$ PC1227V and front-end is shown in Fig. 14.

5



Fig. 3 Limiting Sensitivity Setting by Resistor R<sub>3</sub>

T-77-05-07

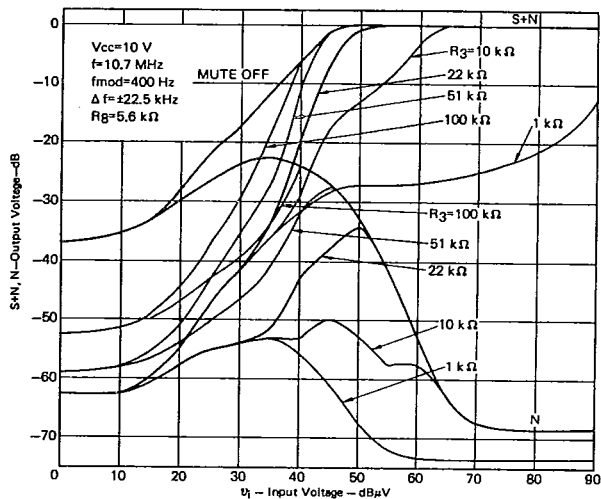
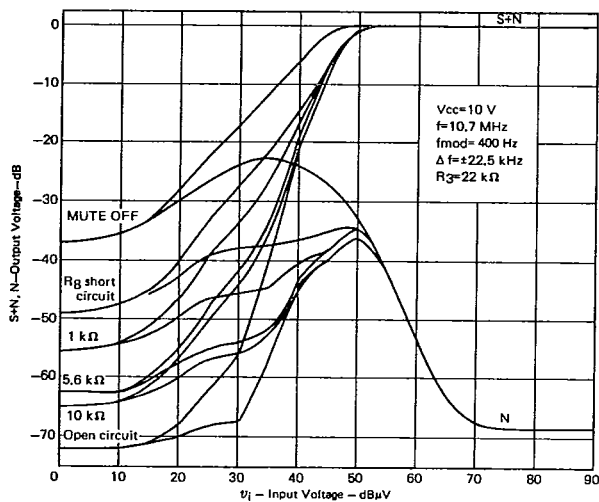

Fig. 4 Muting Attenuation Setting by Resistor R<sub>g</sub>



5

$\mu$ PC1245V  
6427525 N E C ELECTRONICS INC

05E 22798 D

T-77-05-07

Fig. 5 Attenuation Band-width Setting by Resistor R<sub>g</sub>

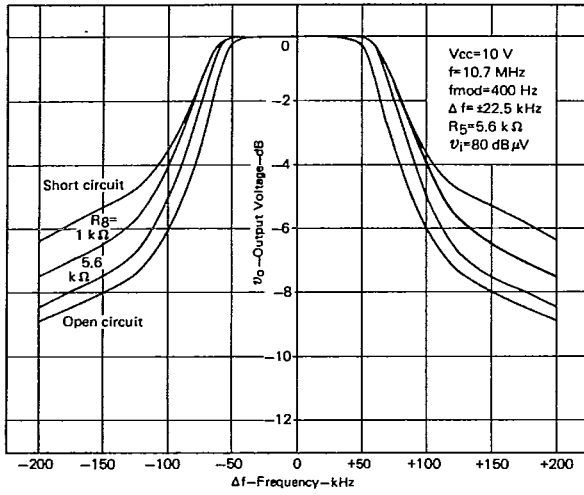
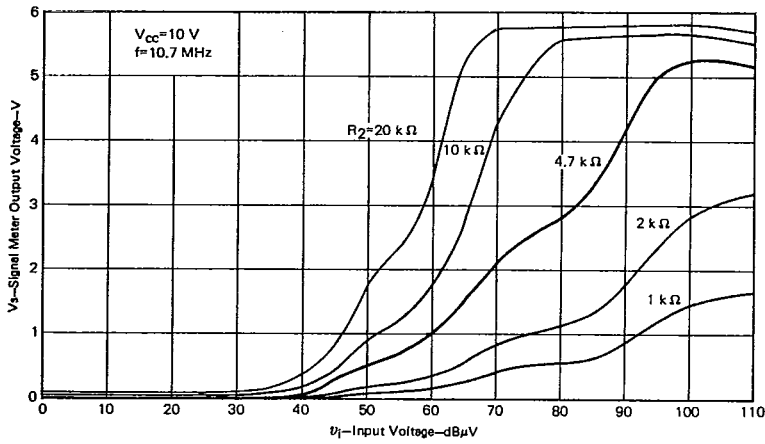

Fig. 6 Signal Meter Output Setting by Resistor R<sub>2</sub>



6427525 N E C ELECTRONICS INC

$\mu$ PC1245V  
05E 22799 D

T-77-05-07

Fig. 7 AGC Sensitivity Setting by Voltage V16

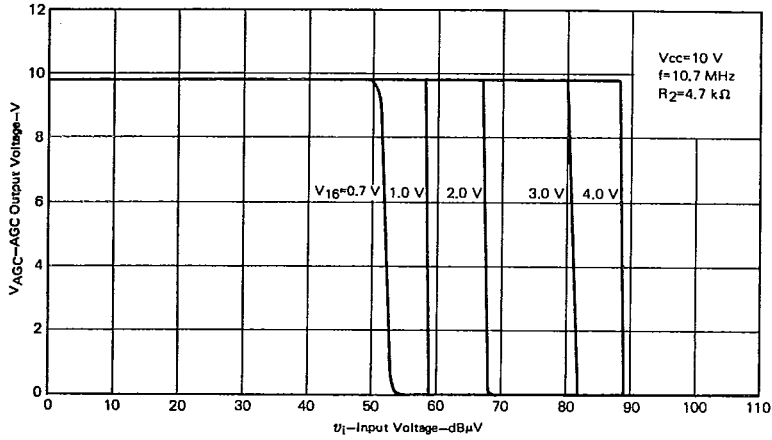
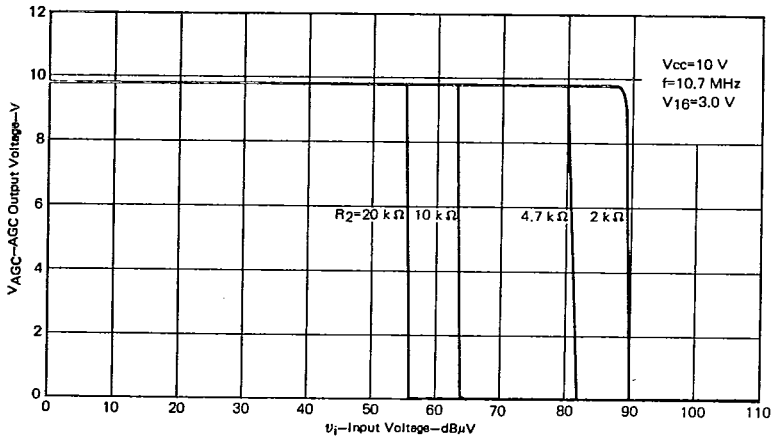

Fig. 8 AGC Sensitivity Setting by Resistor R2



5

$\mu$ PC1245V  
6427525 N E C ELECTRONICS INC

05E 22800 D

T-77-05-07

Fig. 9 SD Sensitivity Setting by Resistor R<sub>3</sub>

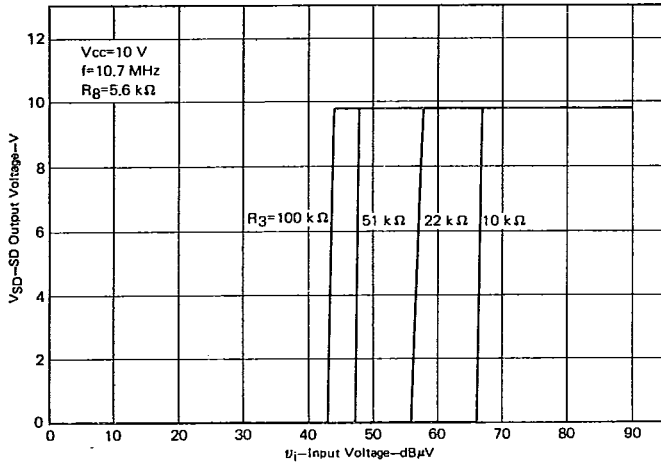
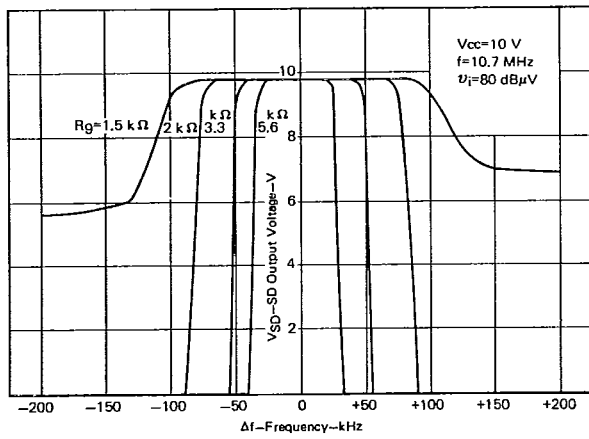

Fig. 10 SD Band-width Setting by Resistor R<sub>g</sub>





6427525 N E C ELECTRONICS INC

$\mu$ PC1245V  
05E 22801 D

Fig. 11 SD Sensitivity Setting by Resistor R<sub>g</sub>

T-77-05-07

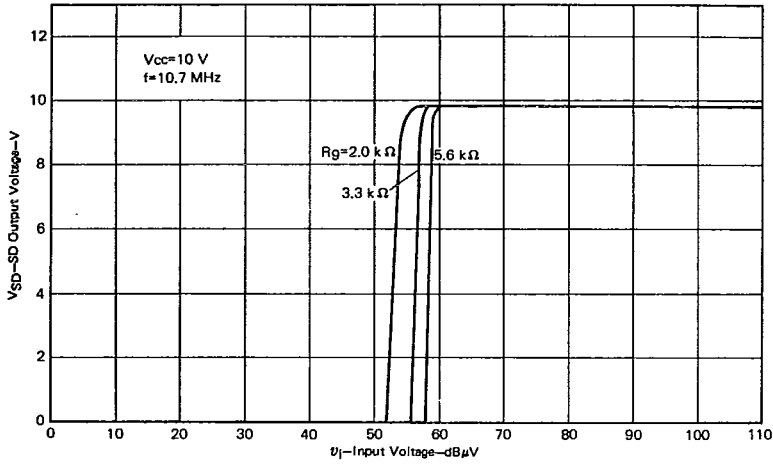
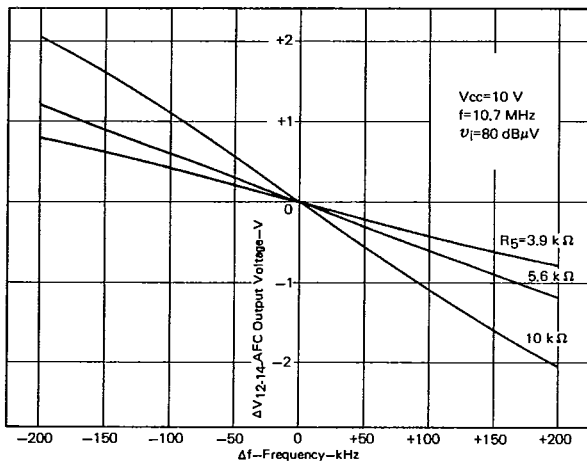

Fig. 12 AFC Sensitivity Setting by Resistor R<sub>5</sub>



5

**μPC1245V**  
 6427525 N E C ELECTRONICS INC

05E 22802 D -

T-77-05-07

Fig. 13 Muting Band-width Setting by Resistor R5

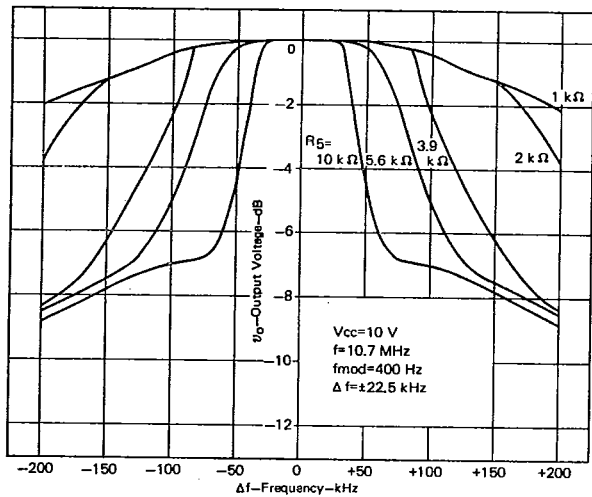

6427525 N E C ELECTRONICS INC

$\mu$ PC1245V  
05E 22803 D

Fig. 14 Overall Characteristics

T-77-05-07

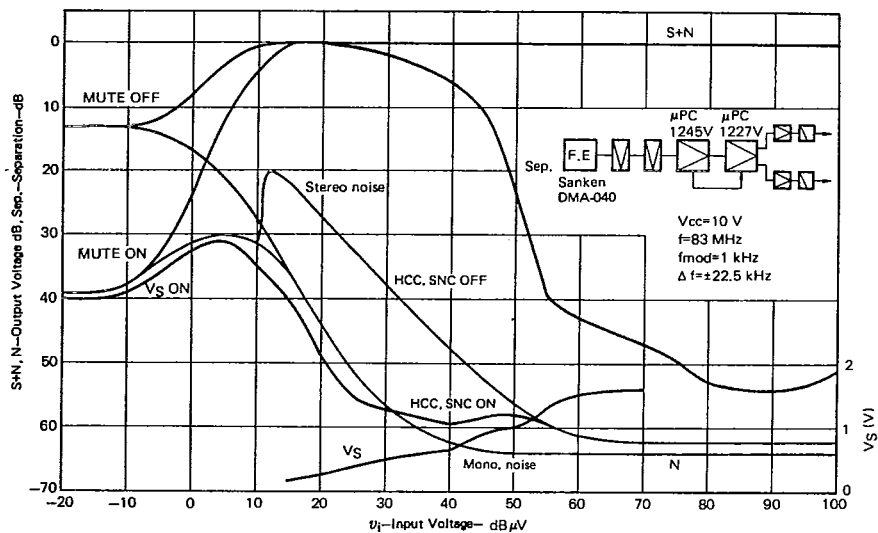

**OTHERS**

Table 1 shows DC voltage of each terminal measured in the test circuit.

Table 2 is external components list and is totally shown on recommended value of external components, tasks, influence exerted to the characteristic in the case of changing the constant, etc.

5

Table 1 DC Voltage of Each Terminal

Terminal No.	1	3	5	7	9	11	13	15	17	19
Voltage (V)	10	0	5.9	2.6	0	3.4	3.4	4.4	0	0
Terminal No.	2	4	6	8	10	12	14	16	18	
Voltage (V)	9.9	5.9	2.5	2.5	0	5.2	5.2	3.0	3.9	

**NOTICE POINTS FOR USE**

- Does not supply voltage 6 V and over on pin (4). If supplying IC may be broken.
- Combined value of external resistor  $R_5$  plus  $R_6$  must be used in 50 k $\Omega$  and over.
- Remove de-emphasis capacitor  $C_{13}$ , when connected multiplex demodulator is used.
- When stop function is used, connect resistor  $R_3$  for muting.

μPC1245V

6427525 N E C ELECTRONICS INC

05E 22804 D

T-77-05-07

Table 2 External Components List

Part No.	Recommended value	Task	Influence		Remarks
			More than recommended value	Less than recommended value	
T		FM detection			119ACS-14891Z (Toko K.K.)
C1	0.022 μF	AGC voltage smoothing	AGC response deterioration	High frequency stability deterioration	SVR, Source ripple removal factor
C2	47 μF	Source decoupling	SW-ON time increase	SVR deterioration	Ceramic capacitor use
C3	0.022 μF	Source decoupling		High frequency stability deterioration	Electrolytic capacitor use
C4	0.022 μF	Reference voltage smoothing		S/N deterioration	Ceramic capacitor use
C5	0.022 μF	Signal meter output smoothing		High frequency stability deterioration	Ceramic capacitor use
C6	0.022 μF	Level muting smoothing		High frequency stability deterioration	Ceramic capacitor use
C7	0.022 μF	IF bypass		High frequency stability deterioration	Ceramic capacitor use
C8	0.022 μF	IF bypass		High frequency stability deterioration	Ceramic capacitor use
C9	0.022 μF	Reference voltage smoothing		High frequency stability deterioration	Ceramic capacitor use
C10	10 pF	Detection circuit	Resonance freq. slip	Resonance freq. slip	
C11	0.47 μF	AFC output smoothing	AFC response deterioration	Muting band-width increase	
C12	3.3 μF	Mute control voltage smoothing	Muting response deterioration	Muting band-width increase	
C13	(0.01 μF)	De-emphasis	High pass f. chara. down	S/N deterioration	
C14	10 μF	Coupling	SW-ON time increase	Low pass f. chara. down	
R1	100 k Ω	AGC load resistor			
R2	4.7 k Ω	Signal meter load resistor	Signal meter output voltage increase	Signal meter output voltage decrease	Refer to Fig. 6
R3	22 k Ω	Limiting sensitivity setting resistor	Limiting sensitivity up	Limiting sensitivity down	Refer to Fig. 3
R4	330 Ω	Impedance matching resistor	Ceramic filter chara. influence large	Loss large	
R5	5.6 k Ω	AFC sensitivity setting resistor	AFC sensitivity up	AFC sensitivity down	Refer to Fig. 12
R6	39 k Ω	AGC sensitivity setting resistor	AGC sensitivity down	AGC sensitivity up	Refer to Fig. 7
R7	56 k Ω	AGC sensitivity setting resistor	AGC sensitivity up	AGC sensitivity down	Refer to Fig. 7
R8	5.6 k Ω	Muting attenuation setting resistor	Muting attenuation decrease	Muting attenuation increase	Refer to Fig. 4
R9	3.3 k Ω	SD sensitivity setting resistor	SD sensitivity down	SD sensitivity up	Refer to Fig. 9
R10	(1 k Ω)	LED drive resistor	LED drive current decrease	LED drive current increase	