

Features

- Direct telephone line operation
- 4 x 3 matrix keyboard interface
- Supply voltage range 2.0V to 5.5V
- Inexpensive RC oscillator
- Low power standby mode for redial
- 22-digit capacity for redial
- Redial with either * or # key
- Dialer reset for line power break > 200 msec
- Inter-digit pause 800ms
- Selectable Make/Break ratio
- Provision for rapid testing (high speed test capacity)
- 16 lead dual-in-line package

General Description

The UM9151-3 pulse dialer is a monolithic CMOS integrated circuit which converts pushbutton inputs to a series of pulses suitable for telephone dialing. It is intended to replace mechanical telephone dialers and can operate directly from the telephone lines.

CMOS technology used to produce this device results in very low power consumption and enables easy interfacing with a variety of telephones with high noise immunity and few external components.

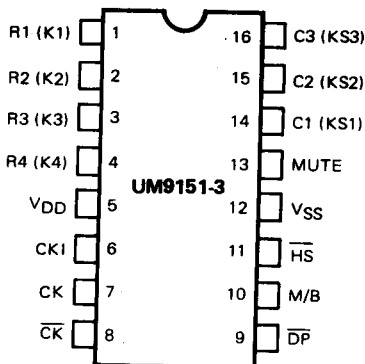
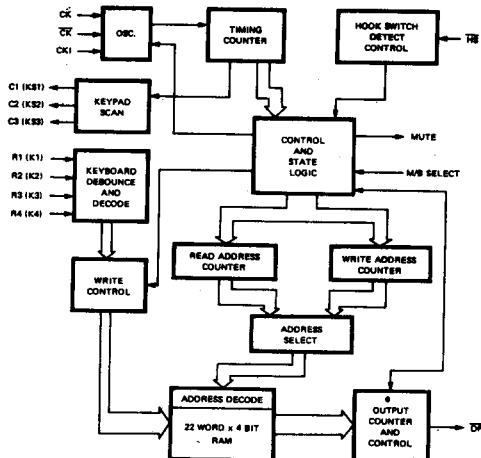
Pin Configuration

Block Diagram

Absolute Maximum Ratings*

DC Supply Voltage ($V_{DD} - V_{SS}$)	-0.3V to 5.5V
Operating Temperature	-20°C to 60°C
Storage Temperature	-55°C to 125°C

***Comments**

Stresses above those listed under "Absolute Maximum Ratings" may cause permanent damage to the device. This is a stress rating only and functional operation of the device at these or any other conditions above those indicated in the operational sections of this specification is not implied.

Electrical Characteristics

($V_{SS} = 0V$, $V_{DD} = 5V$, $T_{OP} = 25^\circ C$, Unless otherwise specified)

Parameter	Min.	Typ.	Max.	Units	Conditions
Operating Current		8.0	40.0	μA	$V_{DD} = 5V$ No Key-In
		30.0	200.0	μA	$V_{DD} = 5V$ Keyboard Key-In
Operating Voltage	2.0	3.9	5.5	V	Off Hook
Keyboard Inputs	40	60	150	μA	$V_{IN} = V_{SS}$
Key Depression Period	30.0	40.0		msec	$V_{IN} = V_{SS}$ or V_{DD}
Clock Frequency	14.3	17.2	18.1	KHz	$V_{DD} = 2.5V$
	17.2	18.0	18.6	KHz	$V_{DD} = 3.9V$
	17.8	18.2	19.5	KHz	$V_{DD} = 5V$
All Inputs: "0"	-0.3	0.0	1.5	V	$V_{DD} = 5V$
All Inputs: "1"	$V_{DD} - 1.5$	V_{DD}	$V_{DD} + 0.3$	V	$V_{DD} = 5V$
Mute Sink Current	2	10.0		mA	$V_{DD} = 2.5V$, $V_O = 0.5V$
Mute Drive Current	1	6.0		mA	$V_{DD} = 2.5V$, $V_O = V_{DD} - 1V$
\overline{DP} Sink Current	2.0	7.0		mA	$V_{DD} = 2.5V$, $V_O = 0.5V$
\overline{DP} Leakage Current	0.0	0.01	1.0	μA	$V_{DD} = 2.5V$, $V_O = 2.5V$
Standby Current		0.5	4	μA	On Hook $V_{DD} = 5V$
		0.2	1	μA	$V_{DD} = 1.5V$

Pin Description
Keyboard ($R_1, R_2, R_3, R_4, C_1, C_2, C_3$)

R_1	1	2	3	
R_2	4	5	6	
R_3	7	8	9	
R_4	*	0	#	(*, #: Redial)
	C_1	C_2	C_3	

These inputs can be interfaced to an XY matrix keyboard or 2 of 7 type keyboard. The keypad inputs are normally held at high. When a key is depressed, scanning signals (typical 200Hz) are presented at C_1, C_2, C_3 inputs and

the dialer can identify the key by examining R_1, R_2, R_3, R_4 inputs. Debouncing is presented to avoid false entry.

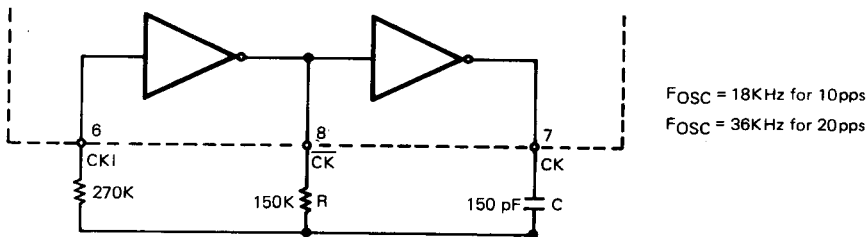
Oscillator (CKI, \overline{CK}, CKO)

This oscillator consists of two inverters, the oscillator frequency is controlled by external RC components
 $R_{CKI} = 270\text{ K}$ $R_{CK} = 150\text{ K}$ $C_{CKO} = 150\text{ pF}$

Hook Switch (\overline{HS} or Handset)

This input is used to detect the telephone is on-hook/off-hook which corresponds to the V_{DD}/V_{SS} condition (Resetting time: 200ms minimum)

Mute

This output structure is an inverter normally at low state when there is no key-entry. High state during out dialling is used to mute the speech network.

Dial pulse (\overline{DP})

This output stage consists of an N. channel open-drain device. The normal output will be "OFF" state during make and "ON" during break, *The PDR = 10pps and IDP = 800 ms when fosc = 18 KHz in normal mode.

Make/Break Ratio Select (M/B)

This input provides the selection of Make/Break ratio in normal mode ($33\frac{1}{3}/66\frac{2}{3}$ or 40 – 60 when M/B is connected to V_{DD}/V_{SS})

*This input can trigger the chip into Test mode when it is connected to the clock output (CK = Pin 7), which generates the high speed dialing (PDR = 600 pps, $I_{DP} = 13.3\text{ ms}$)

Power (V_{DD} , V_{SS})

These are the power supply inputs. This device is designed

to operate at 2.0 to 5.5 volts. Initial power-on reset circuit ensures the circuit resets correctly.

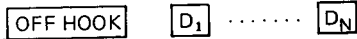
Functional Description
Normal Dialing

Dial pulsing starts as soon as the first key is entered. (Debounced and detected on chip).

Redialing

Last number dialed can be redialed by pressing * or # key

Note: * and # key can be accepted at first key-in entry after off-hook.

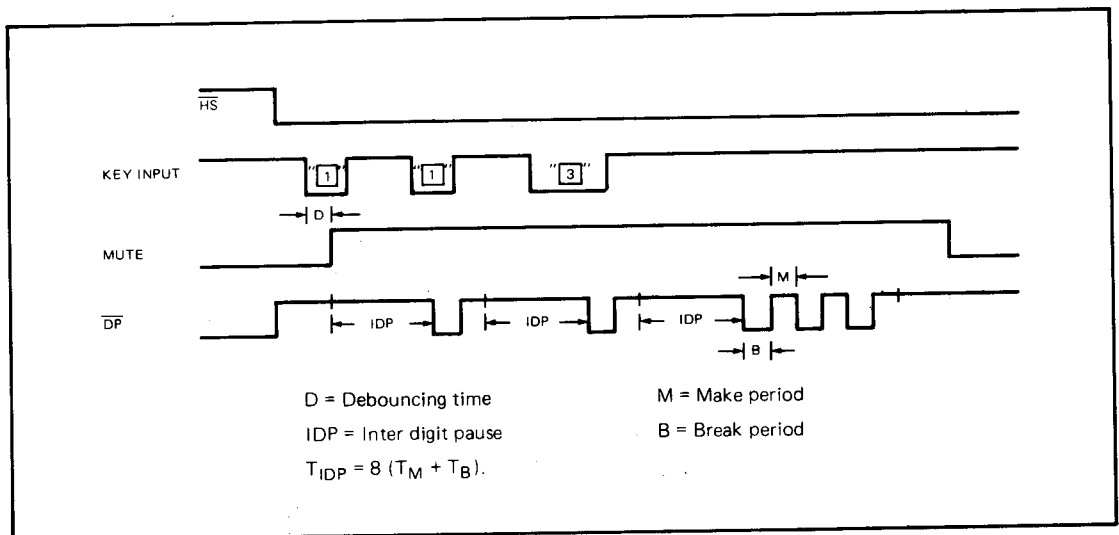
Timing Diagram
Normal Dialing: (Not to Scale)

Redialing: (Assuming the numbers stored in redial memory is 113)

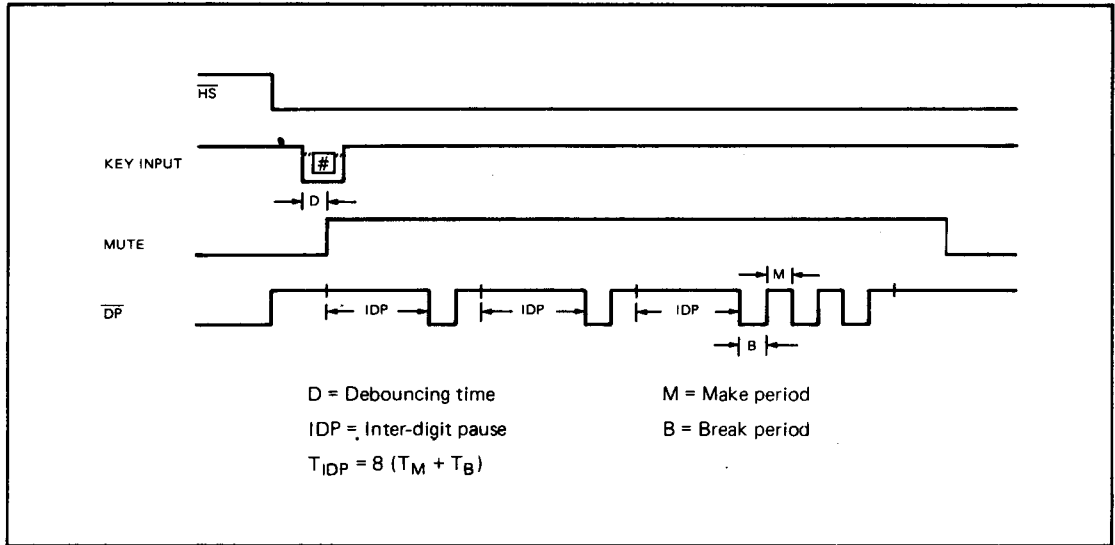

Typical Application

(M/B = 40/60, IDP = 800ms, PDR = 10PPS, $F_{OSC} = 18\text{KHz}$ in this example)

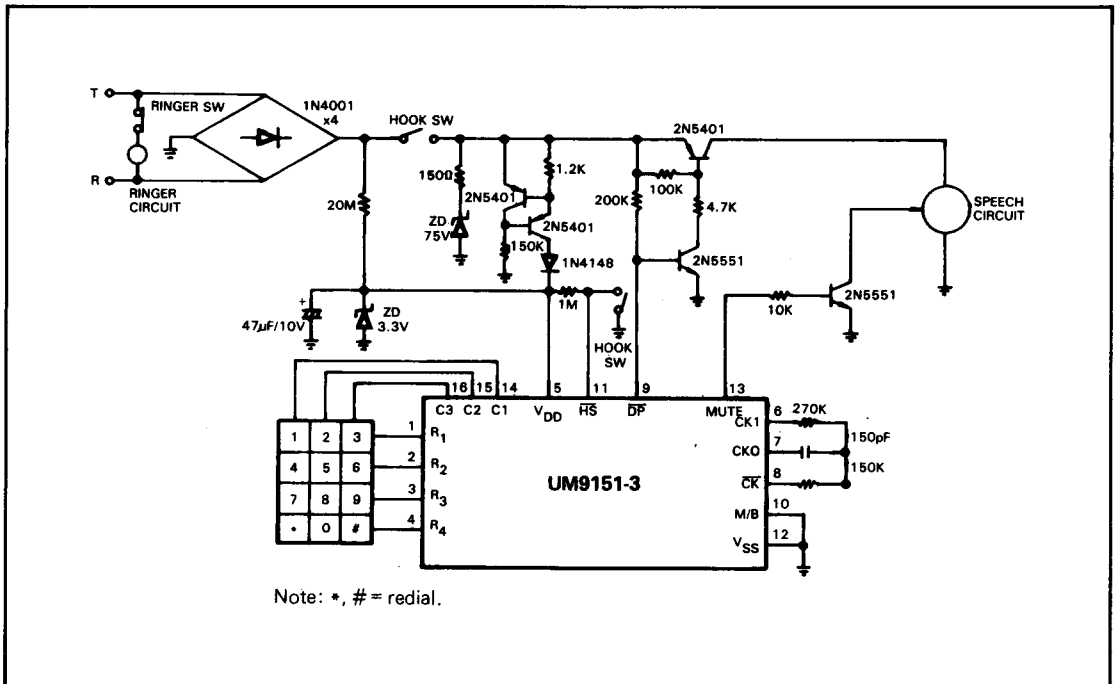

This datasheet has been downloaded from:

www.DatasheetCatalog.com

Datasheets for electronic components.