

# DATA SHEET

## **TBA120U**

Sound I.F. amplifier/demodulator  
for TV

Product specification  
File under Integrated Circuits, IC02

March 1986

**Sound I.F. amplifier/demodulator for TV****TBA120U****GENERAL DESCRIPTION**

The TBA120U is an i.f. amplifier with a symmetrical FM demodulator and an a.f. amplifier with adjustable output voltage. The a.f. amplifier is also provided with an output for volume control and an input for VCR operation.

The input and output of the TBA120U are especially designed for LC-circuits, but the input can also be used with a ceramic filter.

**QUICK REFERENCE DATA**

|   |                          |      |      |               |
|---|--------------------------|------|------|---------------|
| Supply voltage (pin 11)                                       | $V_p$                    | typ. | 12   | V             |
| Supply current  | $I_p$                    | typ. | 13,5 | mA            |
| I.F. voltage gain at $f = 5,5$ MHz                            | $G_{v\text{ if}}$        | typ. | 68   | dB            |
| Input voltage starting limiting                               | $V_i$                    | typ. | 30   | $\mu\text{V}$ |
| AM suppression at $\Delta f = \pm 50$ kHz                     | $\alpha$                 | typ. | 60   | dB            |
| A.F. output voltage adjustment range (pin 8)                  | $\Delta V_{o\text{ af}}$ | typ. | 85   | dB            |
| A.F. output voltage at $\Delta f = \pm 50$ KHz (r.m.s. value) |                          |      |      |               |
| at pin 8  | $V_{o\text{ af (rms)}}$  | typ. | 1,2  | V             |
| at pin 12   | $V_{o\text{ af (rms)}}$  | typ. | 1,0  | V             |

**PACKAGE OUTLINE**

14-lead DIL; plastic (SOT27); SOT27-1; 1996 November 19.

Sound I.F. amplifier/demodulator for TV

TBA120U

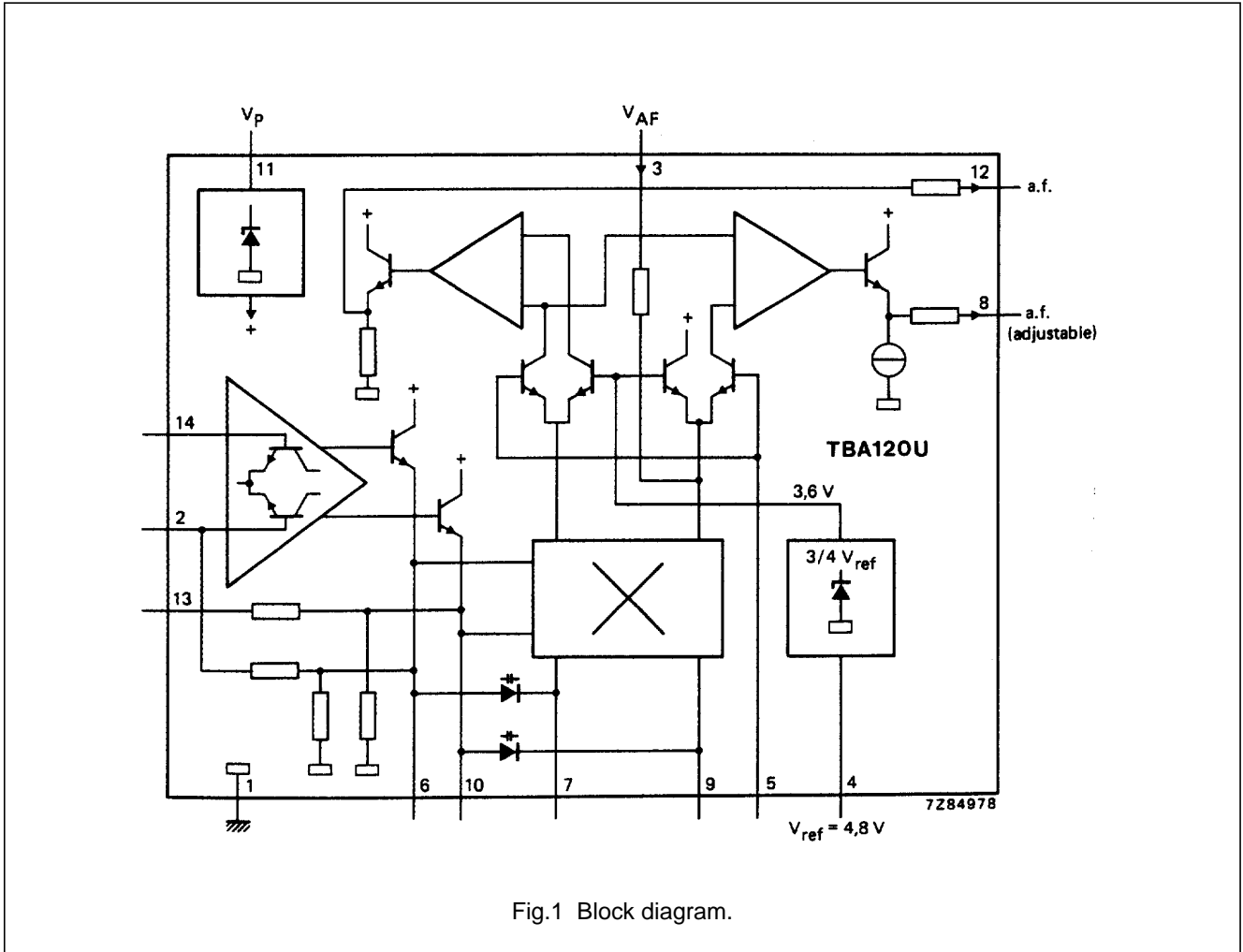

## Sound I.F. amplifier/demodulator for TV

TBA120U

**RATINGS**

Limiting values in accordance with the Absolute Maximum System (IEC 134)

|                                     |                  |      |              |                  |
|-------------------------------------|------------------|------|--------------|------------------|
| Supply voltage (pin 11)             | $V_P = V_{11-1}$ | max. | 18           | V <sup>(1)</sup> |
| Adjustment voltage (pin 5)          | $V_{5-1}$        | max. | 6            | V                |
| Total power dissipation             | $P_{tot}$        | max. | 400          | mW               |
| By-pass resistance                  | $R_{13-14}$      | max. | 1            | k $\Omega$       |
| Storage temperature range           | $T_{stg}$        |      | -40 to + 125 | $^{\circ}$ C     |
| Operating ambient temperature range | $T_{amb}$        |      | 0 to + 70    | $^{\circ}$ C     |

**CHARACTERISTICS** $V_P = 12$  V;  $T_{amb} = 25$   $^{\circ}$ C;  $f = 5,5$  MHz

|  |                           |      |            |            |
|--|---------------------------|------|------------|------------|
| I.F. voltage gain  | $G_{v \text{ if } 6-14}$  | typ. | 68         | dB         |
| Input voltage starting limiting<br>at $\Delta f = \pm 50$ kHz; $f_m = 1$ kHz                 | $V_i$                     | typ. | 30         | $\mu$ V    |
|  |                           | <    | 60         | $\mu$ V    |
| I.F. output voltage at limiting<br>(peak-to-peak value)                                      | $V_o \text{ if (p-p)}$    | typ. | 250        | mV         |
| AM suppression at $\Delta f = \pm 50$ kHz; $V_i = 500$ $\mu$ V;<br>$f_m = 1$ kHz; $m = 30\%$ | $\alpha$                  | >    | 50         | dB         |
|  |                           | typ. | 60         | dB         |
| I.F. residual voltage without de-emphasis<br>at pin 12                                       | $V_{if 12}$               | typ. | 30         | mV         |
| at pin 8   | $V_{if 8}$                | typ. | 20         | mV         |
| A.F. voltage gain  | $G_{v \text{ af } 8-3}$   | typ. | 7,5        |            |
| A.F. adjustment<br>at $R_{4-5} = 5$ k $\Omega$ ; $R_{5-1} = 13$ k $\Omega$                   |                           |      | 20 to 36   | dB         |
| A.F. output voltage control range  | $\Delta V_{o \text{ af}}$ | typ. | 28         | dB         |
|  |                           | >    | 70         | dB         |
|  |                           | typ. | 85         | dB         |
| Adjustment resistor( note 2)   | $R_{4-5}$                 |      | 1 to 10    | k $\Omega$ |
| D.C. voltage portion at the a.f. outputs<br>pin 12   | $V_{12-1}$                | typ. | 5,6        | V          |
| pin 8  | $V_{8-1}$                 | typ. | 4,0        | V          |
| Output resistance of the a.f. outputs<br>pin 12  | $R_{o 12-1}$              | typ. | 1,1        | k $\Omega$ |
| pin 8  | $R_{o 8-1}$               | typ. | 1,1        | k $\Omega$ |
| Input resistance of the a.f. input   | $R_{i 3-1}$               | typ. | 2          | k $\Omega$ |
|  |                           |      | 4,2 to 5,3 | V          |
| Stabilized reference voltage   | $V_{4-1} = V_{ref}$       | typ. | 4,8        | V          |
| Source resistance of reference<br>voltage source   | $R_{4-1}$                 | typ. | 12         | $\Omega$   |

Sound I.F. amplifier/demodulator for TV

TBA120U

Hum suppression

|                         |                 |      |                       |    |
|-------------------------|-----------------|------|-----------------------|----|
| at pin 12               | $V_{12}/V_{11}$ | typ. | 30                    | dB |
| at pin 8                | $V_8/V_{11}$    | typ. | 35                    | dB |
| Supply current (pin 11) | $I_P = I_{11}$  |      | 9,5 to 17,5           | mA |
|                         |                 | typ. | 13,5                  | mA |
| I.F. input impedance    | $ Z_i $         | typ. | 40 k $\Omega$ /4,5    | pF |
|                         |                 | >    | 15 k $\Omega$ / $<$ 6 | pF |

A.F. output voltage at  $\Delta f = \pm 50$  kHz;  $f_m = 1$  kHz;

$V_i = 10$  mV;  $Q_o = 45$ ; r.m.s. value

|           |                    |      |     |   |
|-----------|--------------------|------|-----|---|
| at pin 12 | $V_{o\ af\ (rms)}$ | typ. | 1,0 | V |
| at pin 8  | $V_{o\ af\ (rms)}$ | typ. | 1,2 | V |

Distortion at  $\Delta f = \pm 50$  kHz;  $f_m = 1$  kHz;

$V_i = 10$  mV;  $Q_o = 20$

|           |      |   |   |
|-----------|------|---|---|
| $d_{tot}$ | typ. | 1 | % |
|-----------|------|---|---|

Notes

1. Supply voltage operating range is 10 to 18 V.
2. Pin 5 must be connected to pin 4, when volume control adjustment is not applicable.

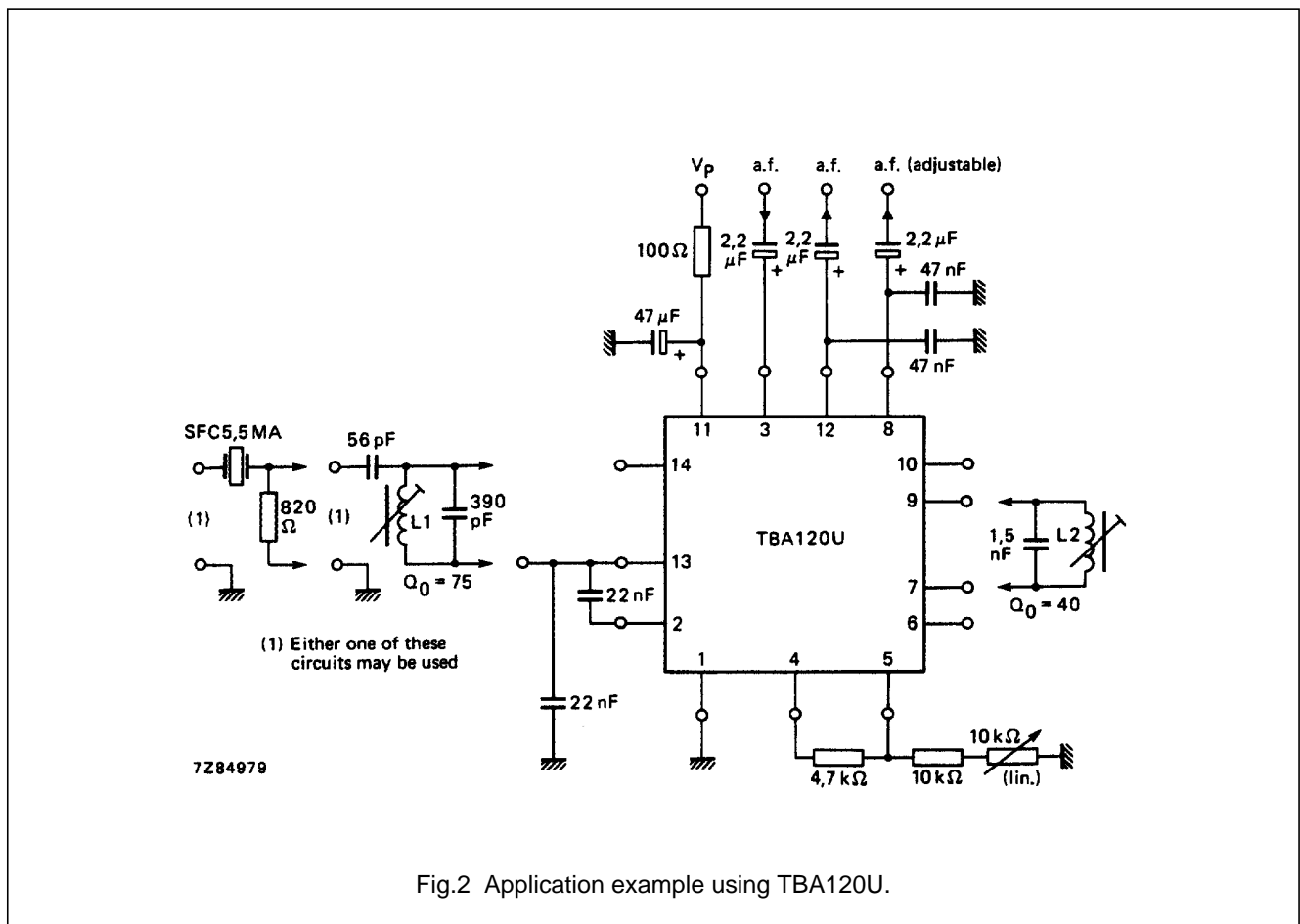
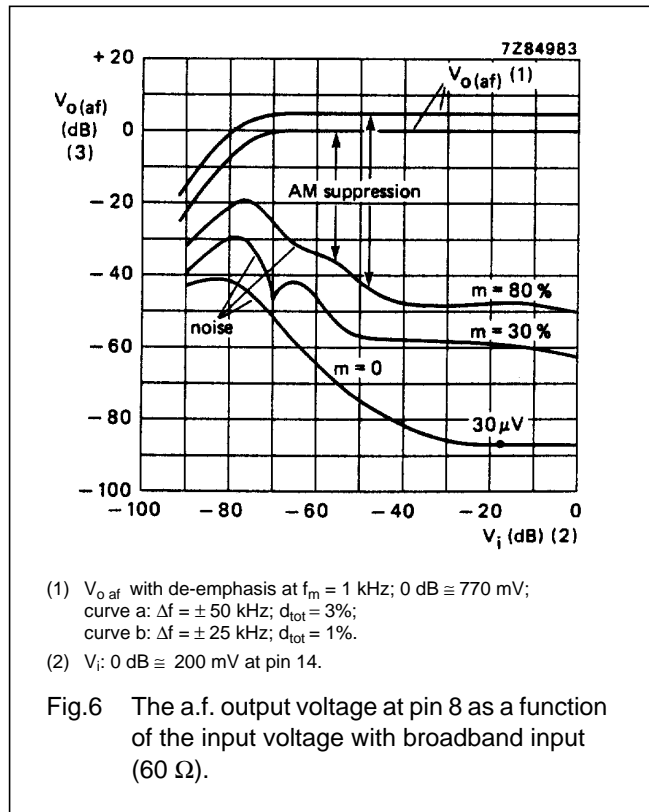
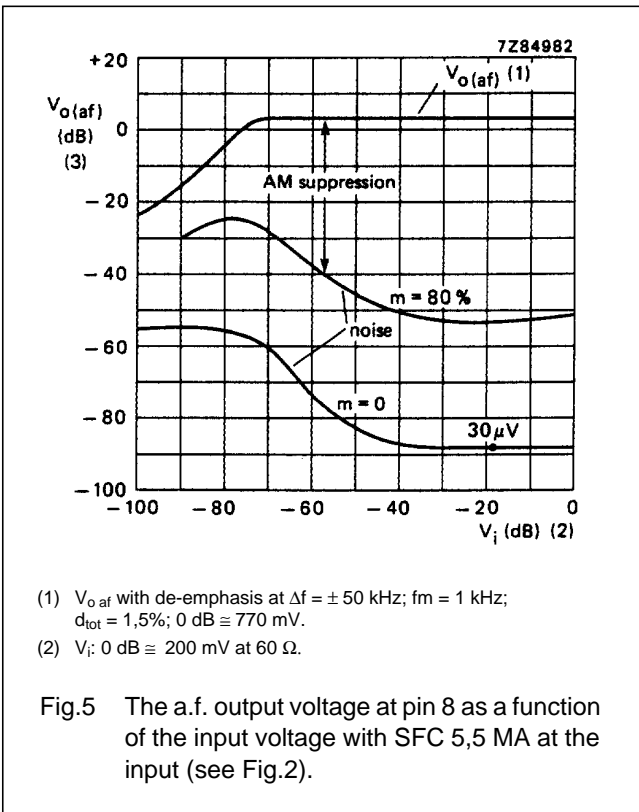
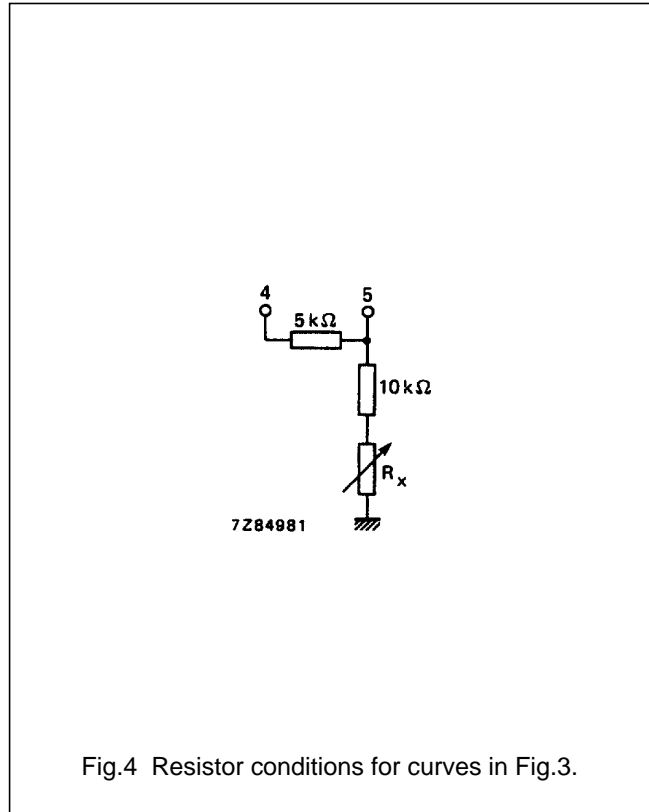
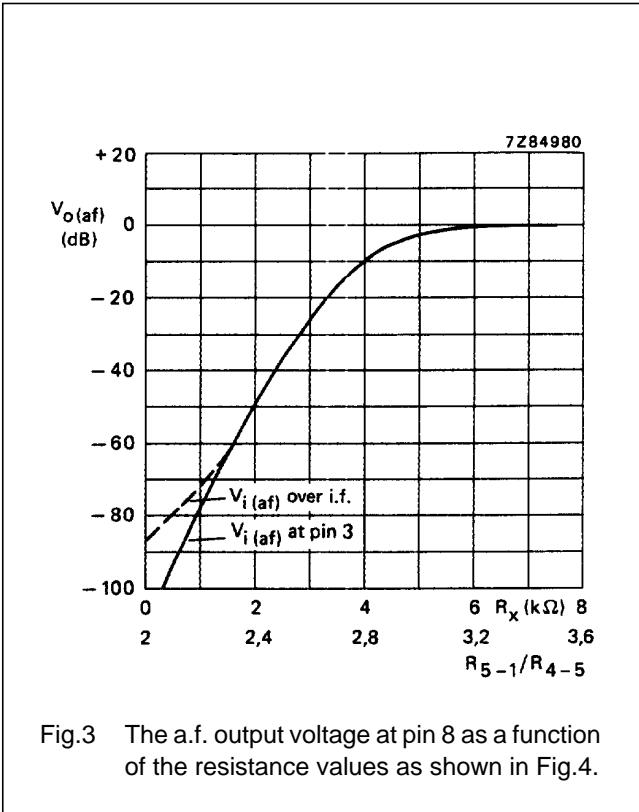

Fig.2 Application example using TBA120U.

Sound I.F. amplifier/demodulator for TV

TBA120U



Sound I.F. amplifier/demodulator for TV

TBA120U

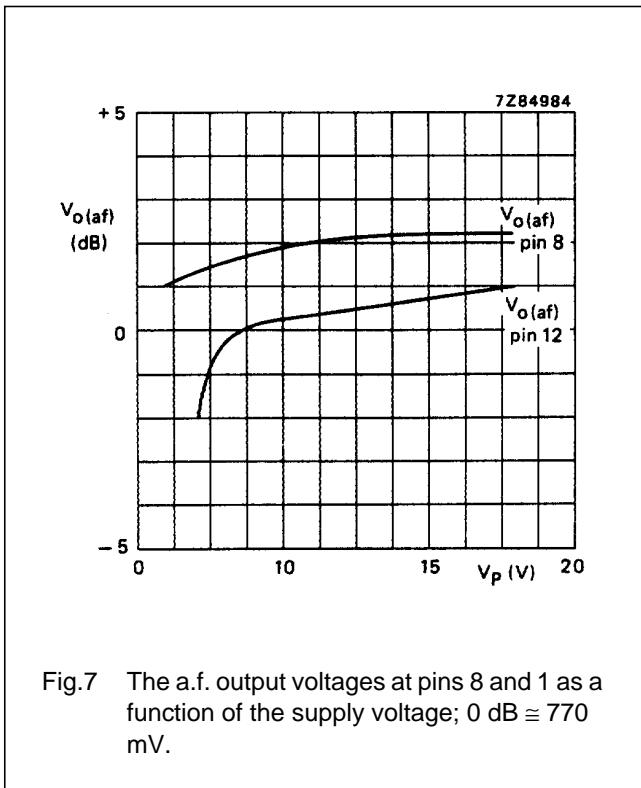

Fig.7 The a.f. output voltages at pins 8 and 1 as a function of the supply voltage; 0 dB  $\cong$  770 mV.

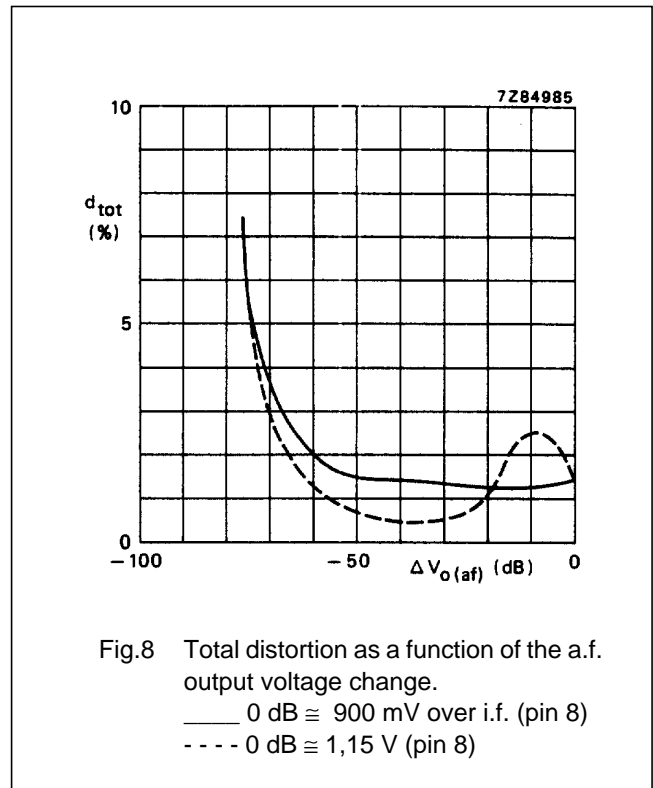

Fig.8 Total distortion as a function of the a.f. output voltage change.  
 — 0 dB  $\cong$  900 mV over i.f. (pin 8)  
 - - - 0 dB  $\cong$  1,15 V (pin 8)

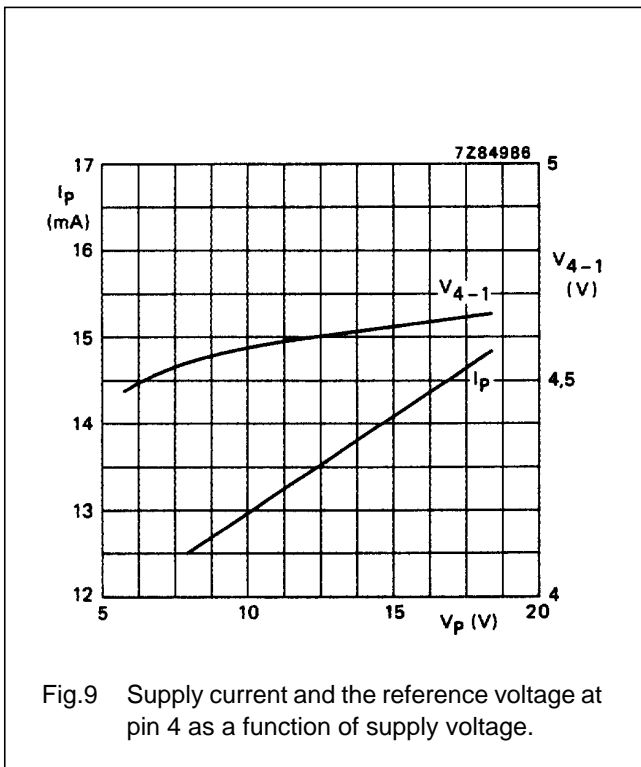

Fig.9 Supply current and the reference voltage at pin 4 as a function of supply voltage.

Sound I.F. amplifier/demodulator for TV

TBA120U

PACKAGE OUTLINE

DIP14: plastic dual in-line package; 14 leads (300 mil)

SOT27-1

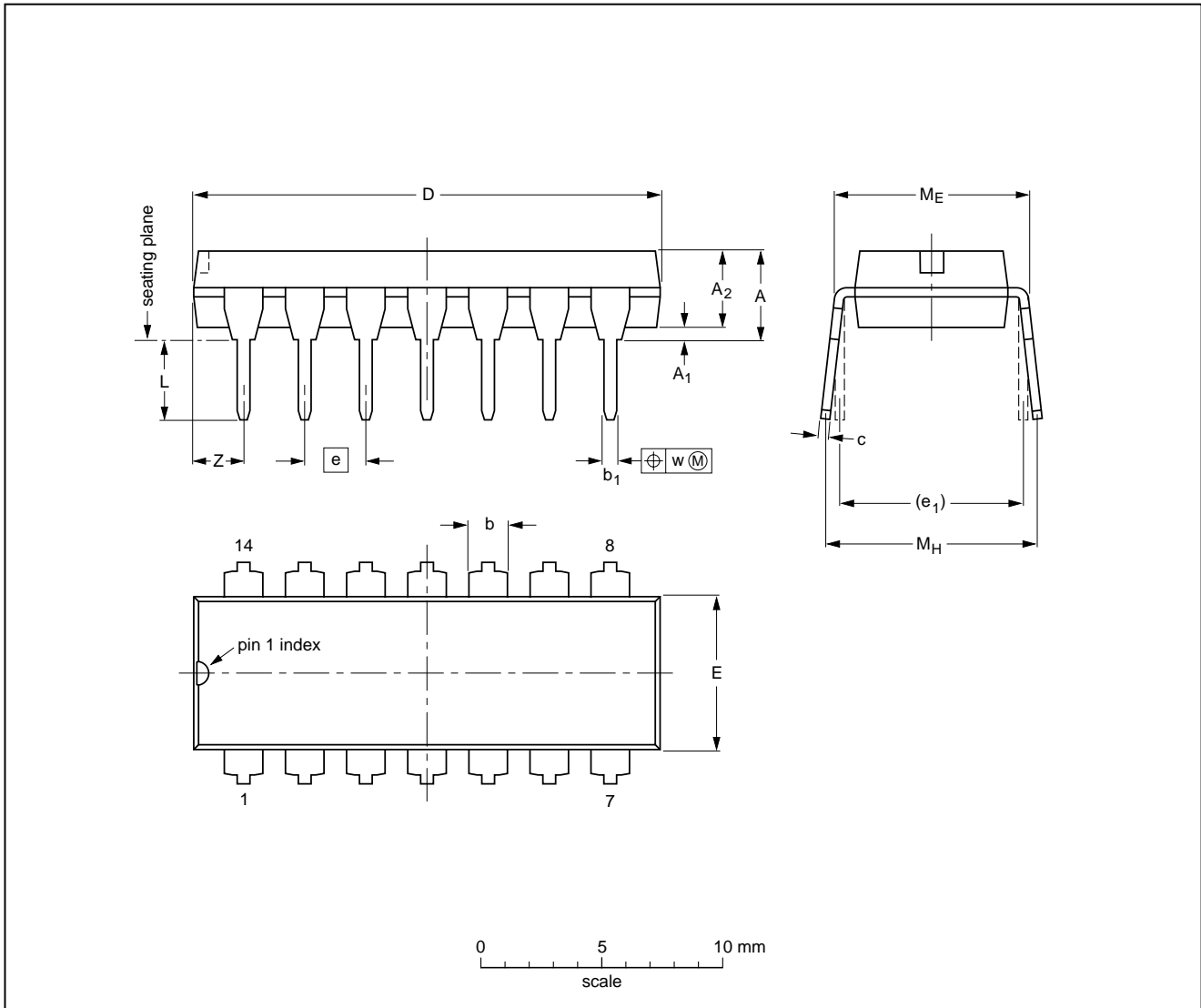

DIMENSIONS (inch dimensions are derived from the original mm dimensions)

| UNIT   | A max. | A <sub>1</sub> min. | A <sub>2</sub> max. | b              | b <sub>1</sub> | c              | D <sup>(1)</sup> | E <sup>(1)</sup> | e    | e <sub>1</sub> | L            | M <sub>E</sub> | M <sub>H</sub> | w     | z <sup>(1)</sup> max. |
|--------|--------|---------------------|---------------------|----------------|----------------|----------------|------------------|------------------|------|----------------|--------------|----------------|----------------|-------|-----------------------|
| mm     | 4.2    | 0.51                | 3.2                 | 1.73<br>1.13   | 0.53<br>0.38   | 0.36<br>0.23   | 19.50<br>18.55   | 6.48<br>6.20     | 2.54 | 7.62           | 3.60<br>3.05 | 8.25<br>7.80   | 10.0<br>8.3    | 0.254 | 2.2                   |
| inches | 0.17   | 0.020               | 0.13                | 0.068<br>0.044 | 0.021<br>0.015 | 0.014<br>0.009 | 0.77<br>0.73     | 0.26<br>0.24     | 0.10 | 0.30           | 0.14<br>0.12 | 0.32<br>0.31   | 0.39<br>0.33   | 0.01  | 0.087                 |

Note

1. Plastic or metal protrusions of 0.25 mm maximum per side are not included.

| OUTLINE VERSION | REFERENCES |          |      |  | EUROPEAN PROJECTION | ISSUE DATE           |
|-----------------|------------|----------|------|--|---------------------|----------------------|
|                 | IEC        | JEDEC    | EIAJ |  |                     |                      |
| SOT27-1         | 050G04     | MO-001AA |      |  |                     | 92-11-17<br>95-03-11 |



## Sound I.F. amplifier/demodulator for TV

TBA120U

### SOLDERING

#### Introduction

There is no soldering method that is ideal for all IC packages. Wave soldering is often preferred when through-hole and surface mounted components are mixed on one printed-circuit board. However, wave soldering is not always suitable for surface mounted ICs, or for printed-circuits with high population densities. In these situations reflow soldering is often used.

This text gives a very brief insight to a complex technology. A more in-depth account of soldering ICs can be found in our "IC Package Databook" (order code 9398 652 90011).

#### Soldering by dipping or by wave

The maximum permissible temperature of the solder is 260 °C; solder at this temperature must not be in contact with the joint for more than 5 seconds. The total contact time of successive solder waves must not exceed 5 seconds.

The device may be mounted up to the seating plane, but the temperature of the plastic body must not exceed the specified maximum storage temperature ( $T_{stg\ max}$ ). If the printed-circuit board has been pre-heated, forced cooling may be necessary immediately after soldering to keep the temperature within the permissible limit.

#### Repairing soldered joints

Apply a low voltage soldering iron (less than 24 V) to the lead(s) of the package, below the seating plane or not more than 2 mm above it. If the temperature of the soldering iron bit is less than 300 °C it may remain in contact for up to 10 seconds. If the bit temperature is between 300 and 400 °C, contact may be up to 5 seconds.

### DEFINITIONS

| Data sheet status   |  |
|---|--|
| Objective specification   | This data sheet contains target or goal specifications for product development.  |
| Preliminary specification   | This data sheet contains preliminary data; supplementary data may be published later.  |
| Product specification   | This data sheet contains final product specifications.   |
| Short-form specification  | The data in this specification is extracted from a full data sheet with the same type number and title. For detailed information see the relevant data sheet or data handbook. |
| Limiting values   |  |
| Limiting values given are in accordance with the Absolute Maximum Rating System (IEC 134). Stress above one or more of the limiting values may cause permanent damage to the device. These are stress ratings only and operation of the device at these or at any other conditions above those given in the Characteristics sections of the specification is not implied. Exposure to limiting values for extended periods may affect device reliability. |  |
| Application information   |  |
| Where application information is given, it is advisory and does not form part of the specification.   |  |

### LIFE SUPPORT APPLICATIONS

These products are not designed for use in life support appliances, devices, or systems where malfunction of these products can reasonably be expected to result in personal injury. Philips customers using or selling these products for use in such applications do so at their own risk and agree to fully indemnify Philips for any damages resulting from such improper use or sale.