

TA7668BP**DUAL PREAMPLIFIER FOR TAPE RECORDER.**

The TA7668BP is a dual preamplifier with ALC and muting designed for use in record/playback amplifier of tape recorder. It is suitable for a stereo set and a radio-cassette recorder.

- . Build-in ALC Detector Circuit.
- . Build-in muting circuit.
- . Operating Supply Voltage Range : $V_{CC}=6\sim 15V$
- . DIP 16 Pin (Dual In-Line Package).

MAXIMUM RATINGS ($T_a=25^\circ C$)

CHARACTERISTIC	SYMBOL	RATING	UNIT
Supply Voltage	V_{CC}	16	V
Power Dissipation (Note)	P_D	750	mW
Operating Temperature	T_{opr}	$-25\sim 75$	$^\circ C$
Storage Temperature	T_{stg}	$-55\sim 150$	$^\circ C$

Note : Derated above $T_a=25^\circ C$ in the proportion of $6mW/^\circ C$.

Unit in mm

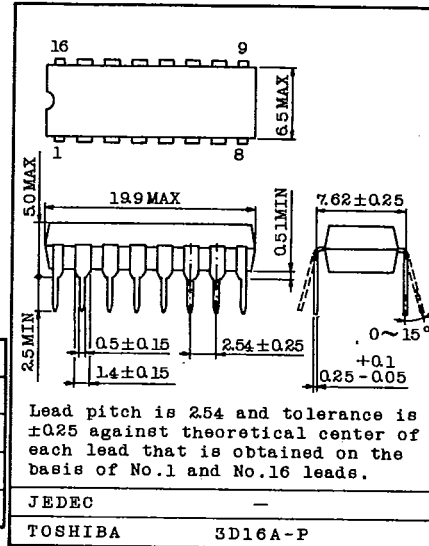
**TYPICAL DC VOLTAGE OF EACH TERMINAL ($V_{CC}=9V, T_a=25^\circ C$, Terminal Voltage at No Signal)**

TERMINAL No.	ITEM	SYMBOL	DC VOLTAGE	UNIT
Terminal 1	Rec. GND	V1	0	V
2	VS	V2	8.2	V
3	Mute OUT	V3	0	V
4	Rec. OUT ch1	V4	3.3	V
5	Pre. OUT & Rec. IN	V5	1.3	V
6	Pre. IN NF	V6	1.3	V
7	Pre. IN	V7	0	V
8	ALC	V8	0.9	V
9	Pre. GND	V9	0	V
10	Pre. IN	V10	0	V
11	Pre. IN NF	V11	1.3	V
12	Pre OUT & Rec. IN	V12	1.3	V
13	Rec. OUT	V13	3.3	V
14	Mute OUT	V14	0	V
15	Mute IN	V15	2.4	V
16	VCC	V16	9.0	V

TOSHIBA

TA7668BP

ELECTRICAL CHARACTERISTICS (Unless otherwise specified, $V_{CC}=9V$, $f=1kHz$, $T_a=25^{\circ}C$)

CHARACTERISTIC		SYMBOL	TEST CIR-CUIT	TEST CONDITION	MIN.	TYP.	MAX.	UNIT
Quiescent Current		ICCQ	1	$V_{IN}=0$	-	8.5	10.5	mA
PRE. AMP	Open Loop Voltage Gain	G _{VO}	1	$V_{IN}=-80dBm$	65	78	-	dB
	Max. Output Voltage	V _{OM(1)}	1	THD=1%	0.5	0.8	-	V _{rms}
	Total Harmonic Distortion	THD(1)	1	$V_O=0.2V_{rms}$	-	0.15	0.5	%
	Output Noise Voltage	V _{NO}	1	$R_g=2.2k\Omega$ B.P.F. NAB 30Hz ~ 20kHz	-	0.26	0.6	mV _{rms}
	Cross Talk	C.T.	1	$R_g=2.2k\Omega$	47	60	-	dB
REC. AMP	Closed Loop Voltage Gain	G _v	1	$R_L=10k\Omega$	12.7	14.7	16.7	dB
	Max. Output Voltage	V _{OM(2)}	1	THD=1%	2.0	2.5	-	V _{rms}
	Total Harmonic Distortion	THD(2)	1	$V_O=1.5V_{rms}$	-	0.2	-	%
	ALC Range (Note 1)	R _{ALC}	1	$V_{IN}=-60dBm, R_{IN}=2.2k\Omega$	-	45	-	dB
	Total Harmonic Distortion (ALC)	THD(ALC)	1	$V_{IN}=-20dBm,$ $R_{IN}=2.2k\Omega, R_L=10k\Omega$	-	0.3	1.0	%
	ALC Voltage	V _{O(ALC)}	1	$V_{IN}=-20dBm,$ $R_{IN}=2.2k\Omega, R_L=10k\Omega$	0.9	1.1	1.42	V _{rms}
Muting Attenuation	ATT	1		45	55	-	dB	
ALC Balance	B _{ALC}	1	$V_{IN}=-20dBm$	-	0	2	dB	

Note 1 : Input voltage range from $V_{IN}=-60dBm$ to output voltage V_{OUT} 3dB up.

TA7668BP

BLOCK DIAGRAM & TEST CIRCUIT 1

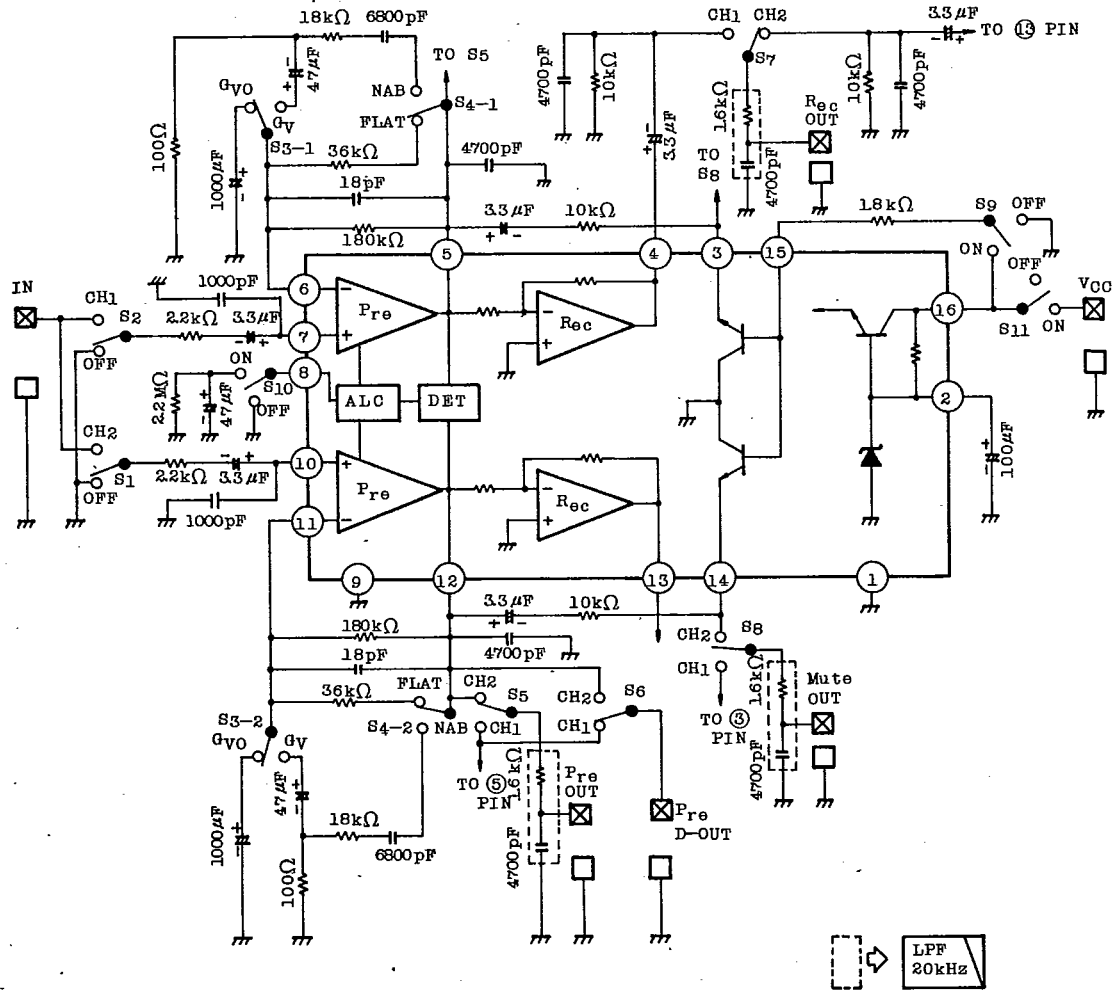

TA7668BP

TEST METHOD

SW SYMBOL	S1	S2	S3	S4	S5	S6	S7	S8	S9	S10	MEASURE TERMINAL
I _{CCQ}	*	*	*	*	*	*	*	*	OFF	*	V _{CC}
G _{VO}	OFF	CH1	G _{VO}	FLAT	CH1	*	*	*	OFF	OFF	Pre OUT
V _{OM(1)}	OFF	CH1	G _V	NAB	CH1	*	*	*	OFF	OFF	Pre OUT
THD(1)	OFF	CH1	G _V	NAB	CH1	*	*	*	OFF	OFF	Pre OUT
V _{NO}	OFF	OFF	G _V	NAB	CH2	CH1	*	*	OFF	OFF	Pre D-OUT
C.T.	OFF	CH1	G _V	FLAT	CH1 →CH2	*	*	*	OFF	OFF	Pre OUT
G _V	OFF	CH1	G _V	FLAT	CH1	*	CH1	CH2	OFF	OFF	Pre OUT →Rec OUT
V _{OM(2)}	OFF	CH1	G _V	FLAT	CH2	*	CH1	CH2	OFF	OFF	Rec OUT
THD(2)	OFF	CH1	G _V	FLAT	CH2	*	CH1	CH2	OFF	OFF	Rec OUT
R _{ALC}	OFF	CH1	G _V	FLAT	CH2	*	CH1	CH2	OFF	ON	Rec OUT
THD(ALC)	OFF	CH1	G _V	FLAT	CH2	*	CH1	CH2	OFF	ON	Rec OUT
V _{O(ALC)}	OFF	CH1	G _V	FLAT	CH2	*	CH1	CH2	OFF	ON	Rec OUT
ATT	OFF	CH1	G _V	FALT	CH1	*	*	CH1	OFF → ON	OFF	Mute OUT
B _{ALC}	CH2	CH1 →CH2	G _V	FLAT	*	*	CH1 →CH2	*	OFF	ON	Rec OUT

* : NO specified.

TA7668BP

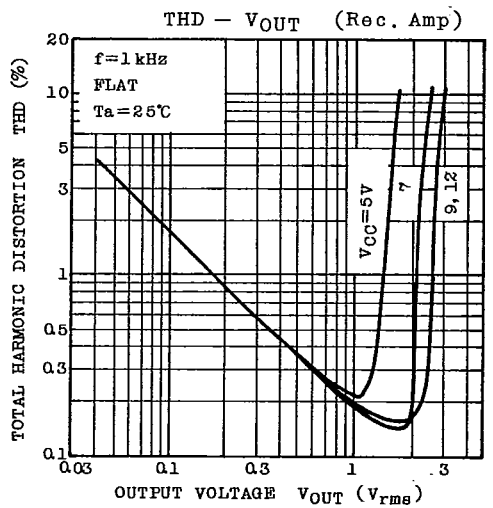
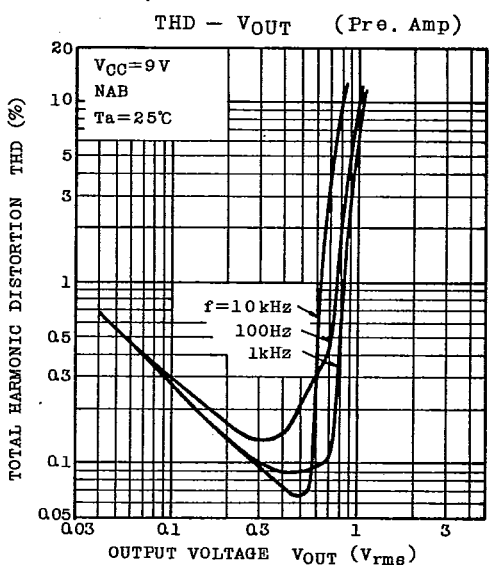
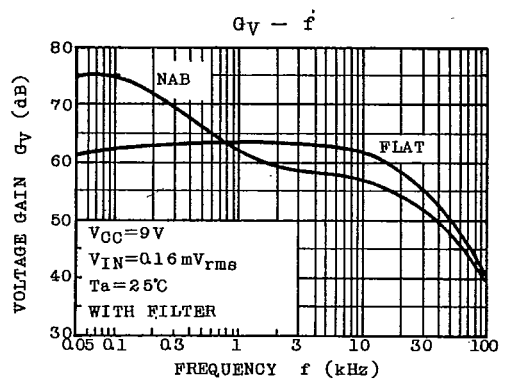
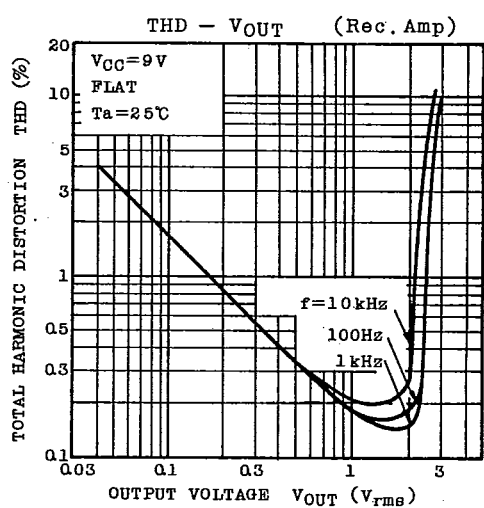
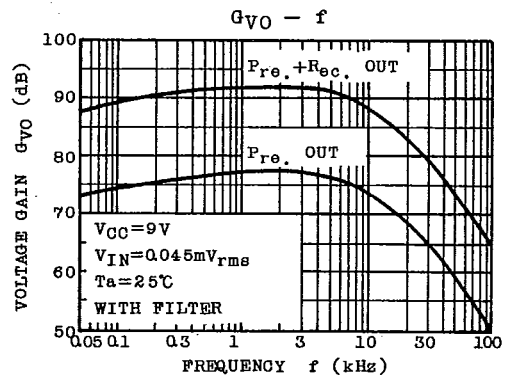

TA7668BP

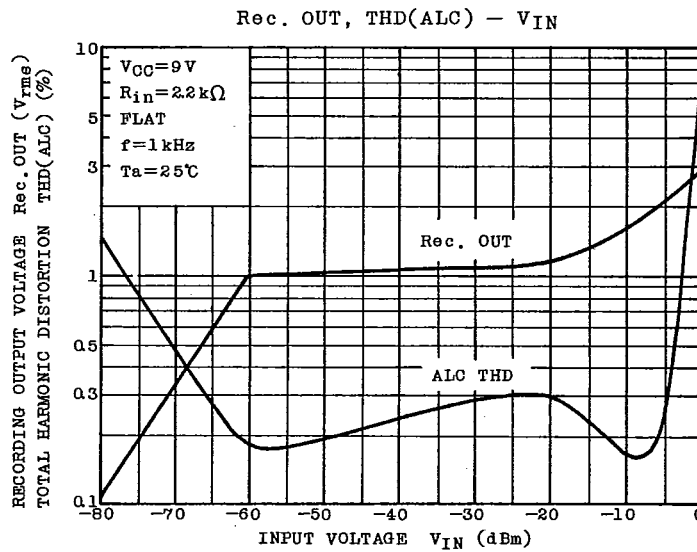
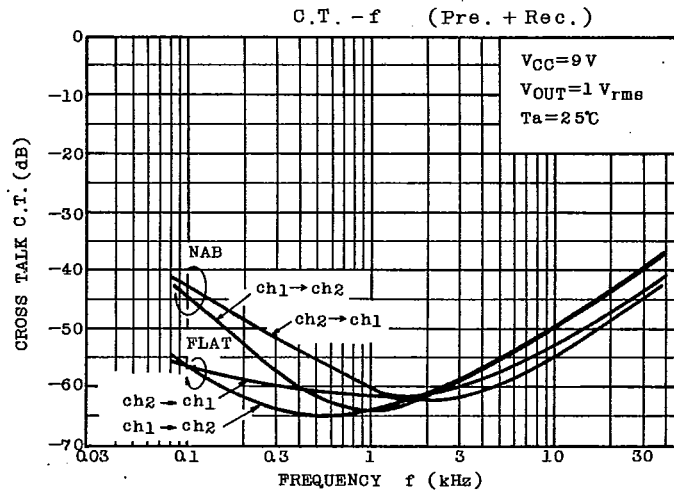

AUDIO LINEAR IC

TA7668BP

